

X

E

prod

e

exteriors by Prodemas<sup>®</sup>

COMPOSITE PANELS  
WITH NATURAL WOOD VENEER

**Prodemas<sup>®</sup>**  
Made to last wooden Products

**Prodemas<sup>®</sup>**  
Made to last wooden Products

COMPOSITE PANELS  
WITH NATURAL WOOD VENEER

**Prodema**<sup>®</sup>  
Made to last wooden Products

The background of the entire page is a close-up, warm-toned wood grain. Overlaid on this are several thin, black, curved lines that intersect to form abstract, organic shapes, possibly suggesting the grain's natural patterns or the curves of a piece of furniture.

# Warm, Beautiful, Elegant...

These are just some of the words that spring to people's minds when they think of wood as a material for construction and decoration.

Wood, as a material that is widely available in nature, has been worked by man for thousands of years, and its applications have gradually been mastered over time.

At **Prodema** we have absorbed and concentrated all that age-old experience, we have updated it, adding a large dose of state-of-the-art technology, to create an original and avant-garde range of natural wood products for the world of architecture and decoration, which had been inconceivable up until recent years, for their appearance, quality, range and, above all, durability.



THERE ARE PLACES WHERE WE SHOULD  
NEVER BUILD

However, when it is necessary, it should be done with materials which best adapt to nature; the very products of nature such as those made by **Prodema: natural wood composites** entirely committed to the most **sustainable architecture**.

<b>Class and comfort</b>	11
<b>Quality</b>	13
<b>Corporate Social Responsibility</b>	15
<b>Healthy architecture</b>	17
<b>Prodema around the world</b>	19
<b>Let your style show</b>	23

## 1. ProdEX material

1.1.	Characteristics of natural wood	25
1.2.	Composition of panels	29
1.3.	Main features	30
1.4.	Sizes and weight	32
1.5.	Colours	33
1.6.	Technical characteristics	43

## 2. Mounting systems

2.1.	Ventilated façade	44
2.2.	Joints and dimensional stability of the panel	47
	2.2.1. Expansion joints	47
	2.2.2. Dimensional stability	48
2.3.	Sub-structure	49
	2.3.1. Different types of strips and auxiliary elements	49
	2.3.2. Minimum points of support per panel	50
	2.3.3. Anchoring to the façade	51
2.4.	Types of fixing	52
	2.4.1. Exposed fixing	52
	2.4.2. Concealed fixing with hanging profiles	55
	2.4.3. Concealed fixing with gluing system	58
2.5.	Solutions to corners	62
2.6.	Unusual façades	63

## 3. Product care and handling

3.1.	Transport	65
3.2.	Storage	65
3.3.	Machining	66
	3.3.1. Cutting recommendations	66
	3.3.2. Drilling recommendations	68
3.4.	Remove surface protection film	70
3.5.	Maintenance and cleaning	71
3.6.	Repairing a damaged panel	72

## 4. Accessories

4.1.	Strips	73
	4.1.1. Aluminium	73
	4.1.2. Steel	73
4.2.	Elements for fixing to the façade	74
	4.2.1. Aluminium	74
	4.2.2. Steel	74
4.3.	Screws and rivets	75
	4.3.1. Fixing the board to the metal strip	75
	4.3.2. Fixing the board to the wooden strip	75
	4.3.3. Fixing the board to the hanging hook	77
	4.3.4. Levelling pin	77
4.4.	Auxiliary elements	77
	4.4.1. Screwdriver	77

<b>Other Prodema products</b>	79
-------------------------------	----

# index



**Prodema**<sup>®</sup>  
Made to last wooden Products

THE COMPANY

# Class and comfort

Here at **Prodema** we are convinced that it's not really a question of selling our wooden products, but rather the added value that the class, elegance, design and comfort that our products bring to our clients' architectural and decoration projects. For us, adapting ourselves perfectly to the design of a project is an essential requirement. That is why we are committed to innovation and to continue our quest to find wood-based architectural solutions for the creation of warm and comfortable spaces.



# Quality



What's left to say about quality? However, at **Prodema** we are particularly sensitive to this concept, as we are aware of how demanding our clients are and, above all, how demanding our clients' clients are. For that reason we make twice the effort. We understand quality to be an intrinsic part of the product as well as the service we offer.

**Prodema** has a management system certified with the ISO 9001 standard.

## CERTIFICATES AND WARRANTIES

**Prodema**, as part of its philosophy of constant improvement, relies on internationally renowned external companies to certify its products and processes.

**Prodema** is registered with the following standards:

- ISO 9001 on Quality Management.
- ISO 14001 on the Environment.
- Chain of Custody of forest products according to the PEFC on request for **ProdEX** panels.
- ISO 14006 in ECOdesign. Product life cycle analysis (LCA) applied to all stages from the extraction of raw materials to the end of the life cycle.

**ProdEX** meets the requirements of standard EN 438 and has the following product / construction system certificates:

- AVIS TECHNIQUE from the CSTB (France).
- ZULASSUNG from the DITB (Germany).
- DIT Plus (Spain).
- NFPA 285 of INTERTEK US (United States).
- CAN S134 of INTERTEK C (Canada).



**ProdEX's** excellent features have been tested in prestigious laboratories, the following stand out:

- Reaction to fire: EN-13501
- Graffiti resistance: ASTM D 6578

**Prodema** carries out a comprehensive quality control on **ProdEX** material and offers a 10-year warranty\* for this product.

\* The general warranty conditions may be changed without prior notice.

For those panels that are not installed vertically, the warranty will be reduced to 5 years, due to the fact that the surface may age faster as a consequence of the greater angle of incidence of the solar radiation and due to the fact that rainwater may remain on the surface.

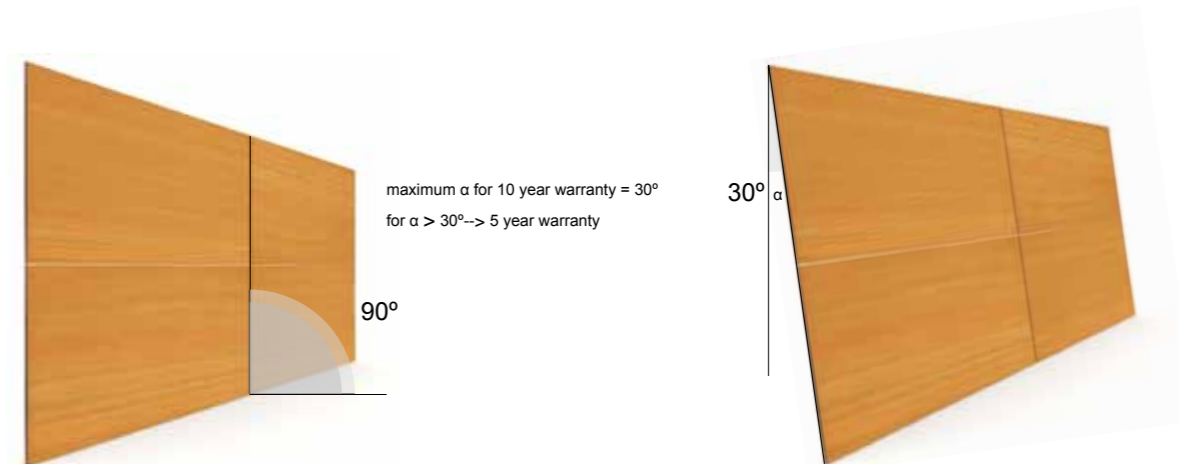

# Corporate Social Responsibility



At **Prodema** we love wood, because it is our life and livelihood. This is why, apart from strictly meeting all international standards, we have also launched a plan that we have called “Friends with nature” in which we will heighten our support for all matters related to sustainable forest management.

This is why **Prodema's** products are manufactured in accordance with the most rigorous environmental requirements of the UNE-EN ISO 14.001 and UNE-EN ISO 14.006 standards for ECOdesign management, which means continuous improvement throughout the product life cycle to reduce environmental impact.

In addition, upon request, **ProdEX** panels can be requested with PEFC certificates which guarantee that the wood and other products of wood origin used to manufacture the **ProdEX** panels are from forests that are managed in an environmentally sustainable fashion.



# Healthy architecture

**Prodema.**  
New warm and comfortable areas that improve the life quality of its inhabitants.



The impact of buildings on our physical and mental well being has been proven. The greater the sum of an area's sensorial and extra-sensorial well being the healthier the area.

At **Prodema**, as leaders in wood products for both indoor and outdoor, we develop solutions for a kind of architecture that is healthier in every way:

- Allowing for **better air circulation** by applying a ventilated façade based solution.
- Creating environments that are free of aggressive agents as we are dealing with a **100% natural product**.

- Allowing for improved **sound insulation**.

- Favouring the environment thanks to our policy of **total sustainability**.

- Making new colours such as **wint** available to architects; for the design of buildings with a greener and more natural image, to achieve the greatest possible integration of the building into its environment and to evoke areas which are less urban, wilder and more idyllic.

And above all, creating warm and comfortable areas that improve the life quality of its inhabitants.



# Prodema around the world

**Prodema** means beauty, warmth and experience in wooden floors and coverings.

We have been working in this field for over 100 years, and this experience has enabled us to become what we are today: a reputable brand respected by architects around the world, who have found in our products the breath of fresh air they had been looking for to meet their creative needs.

With over 75 regional offices all over the world, **Prodema** is now a global trademark and can be seen in many of the large-scale architectural projects in a wide range of countries.



Sherwood Park Nottingham • UK



Playgolf East Kilbride • UK



Aragano • Chile

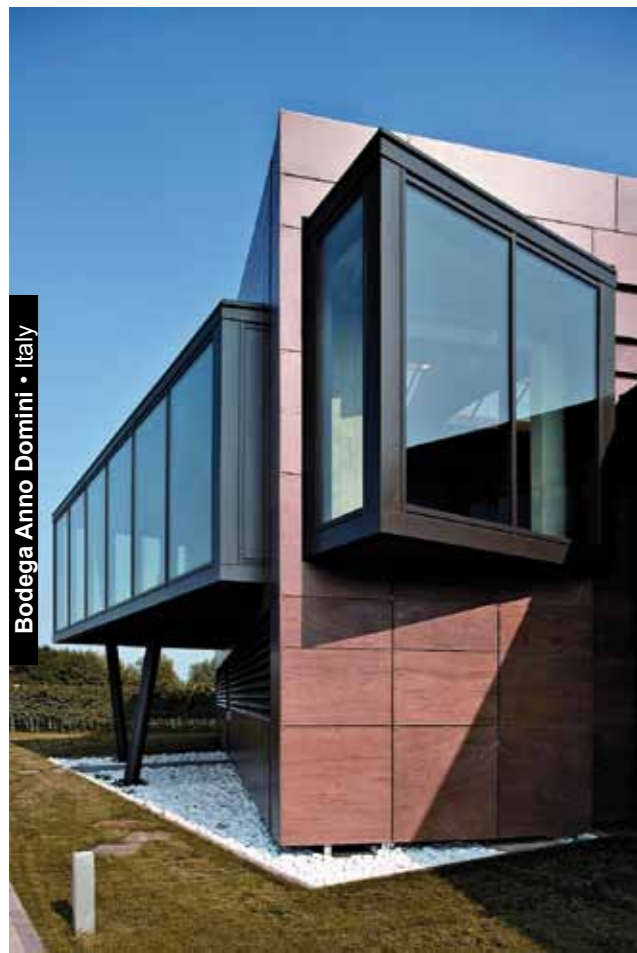

Bodega Anno Domini • Italy

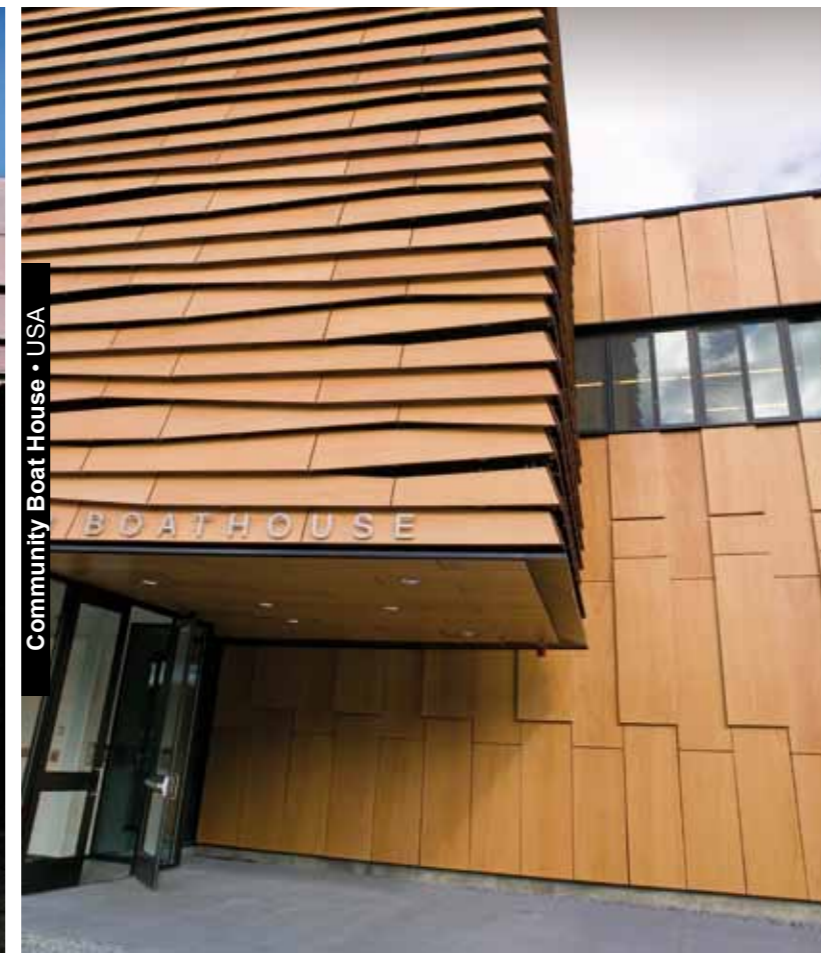

Community Boat House • USA



Hill Side Zürich • Switzerland

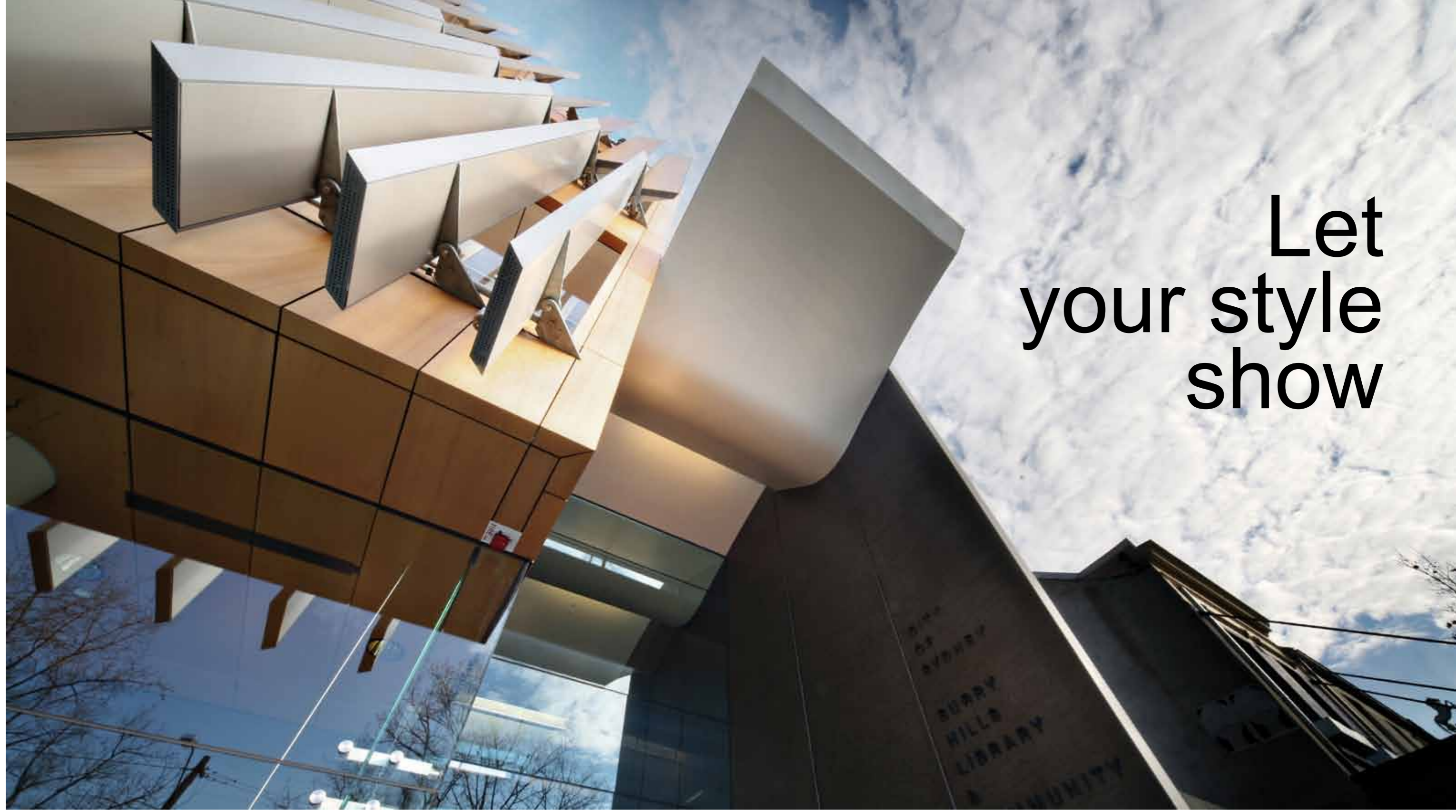

# Let your style show

**ProdEX** (by **Prodema**), our updated line of exterior coverings, is changing the way of thinking in the world of architecture across the globe.

At long last, **ProdEX** (by **Prodema**) provides a class of product which brings together all the good points of such a noble, beautiful and versatile material as wood, and the guarantee of performance and durability that our patented paper and resin-based formula provides.

A whole new world of possibilities for those architects or building technicians who are looking for a genuine alternative to other cold, grey and common materials to cover their building façades.

# 1. ProdEX material

## 1.1. Characteristics of natural wood

**ProdEX** belongs to a new generation of products, and **Prodema**, is one of the only companies on the market manufacturing exterior façade panels with wood veneer. **ProdEX** panels may show certain characteristics that are inherent of natural wood itself, such as those indicated in the following examples:



► Transversal mirror images in the wood.

**Hamburg Bogenallee**  
Blauraum Architekten Hamburg (Germany)

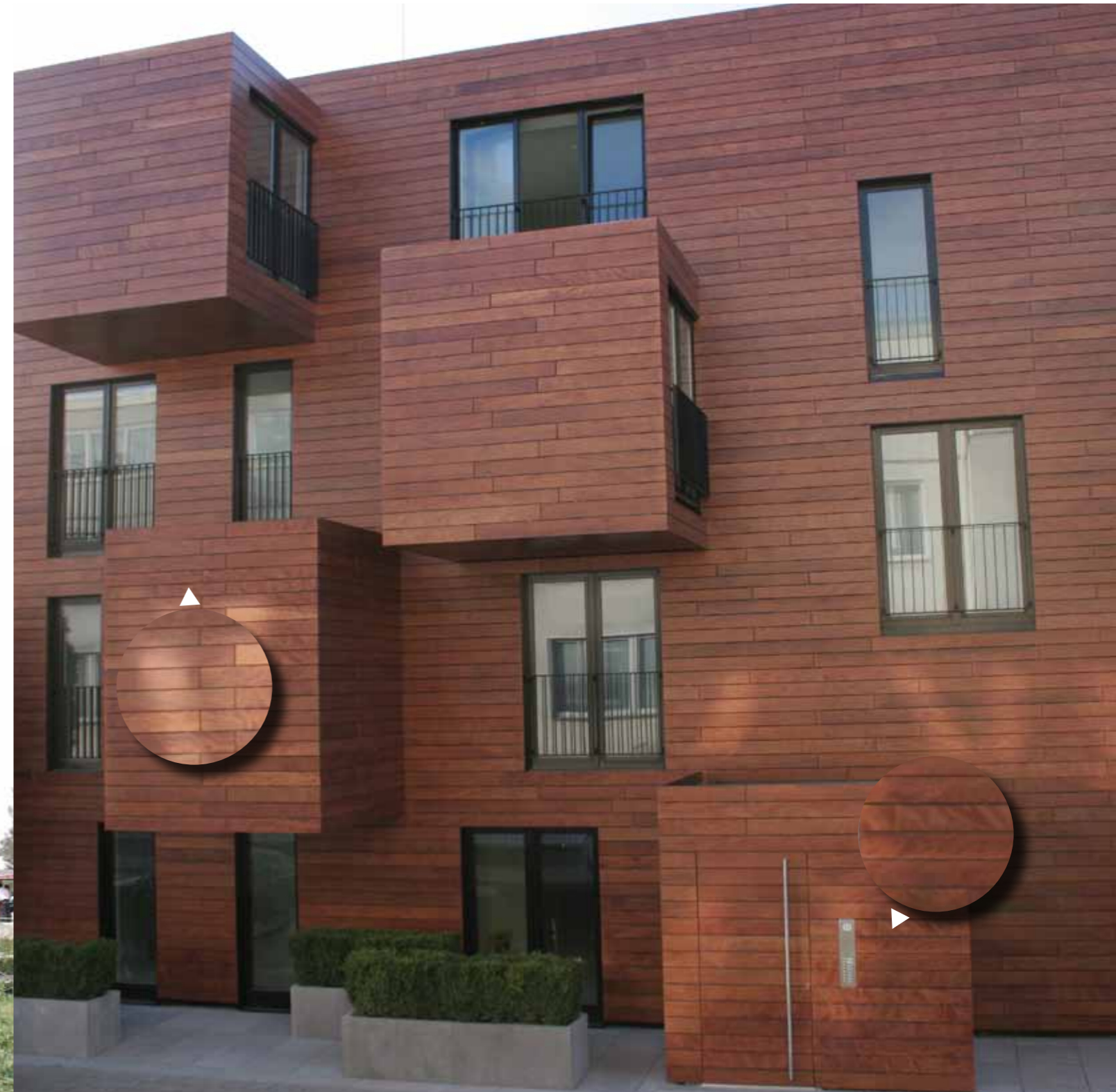

► Variation in colour, shade and shine of different panels made of the same type of wood.

► Knots or holes in the wood coming from the trees themselves.

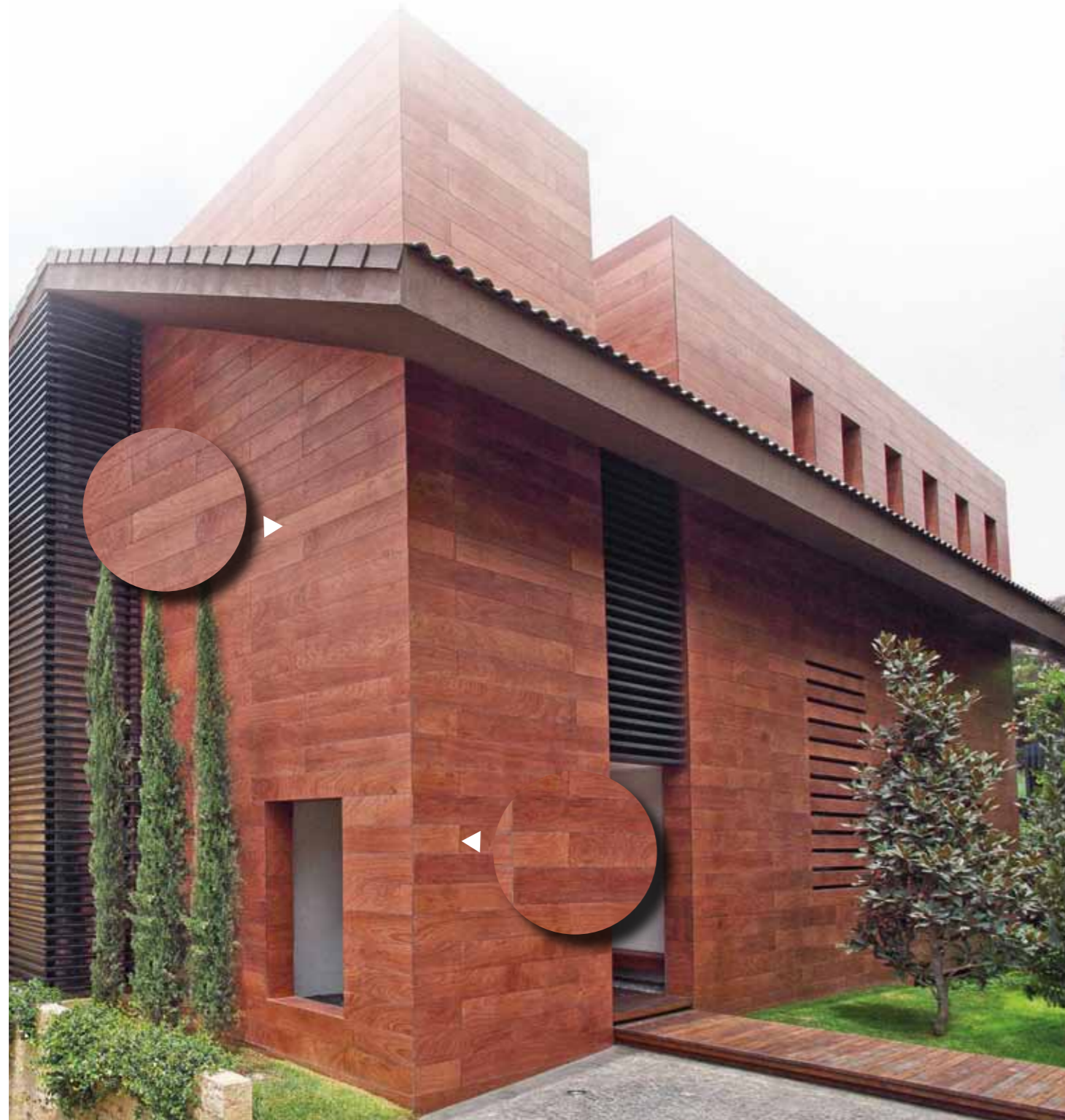

**Hindleap Warren Outdoor Education Centre**  
Architekt RDJW Architects - London (UK)

## 1.2. Composition of panels

**ProdEX** is a composite panel faced with a natural wood veneer and coated with a proprietary coating, based on synthetic resins and PVDF, which protect the panel from the effects of sunlight, chemical attack (anti-graffiti) and the damage caused by atmospheric agents.

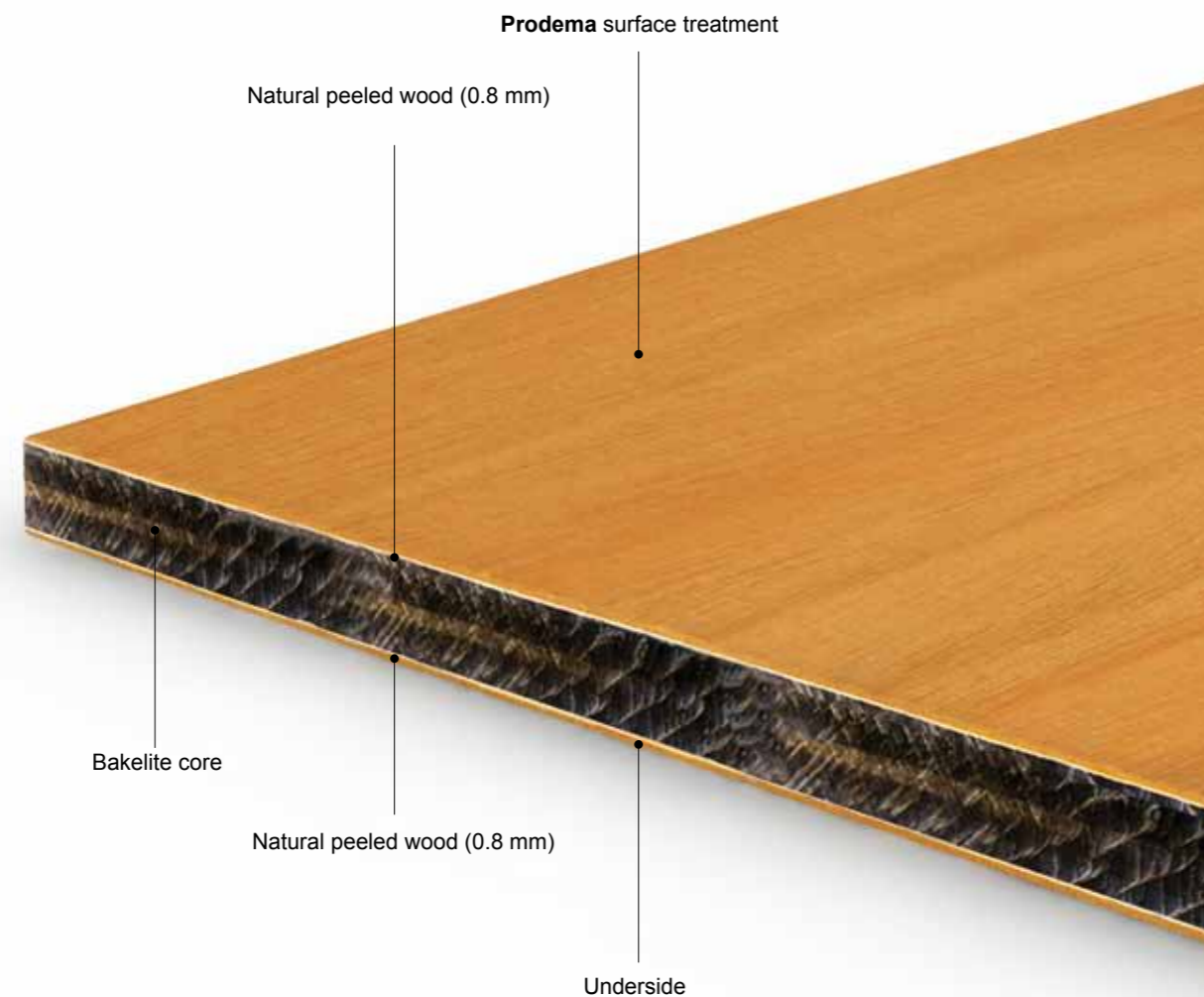

## 1.3. Main features

The different layers of material give the panel its unique characteristics:

### Appearance

- Attractive aesthetic qualities due to the nature of the product – natural wood.
- Solid colour according to EN 438-2 standard, Sect. 28 and 29.

### Resistance and durability

- **Density**  $\geq 1.35 \text{ gr/cm}^3$ .
- **High mechanical resistance.** Flexural strength  $> 80 \text{ MPa}$  and modulus of elasticity  $> 9000 \text{ MPa}$ .
- **High resistance to weather.** In the artificial ageing tests, **ProdEX** obtains a colour stability of  $\geq 3$  after 9.000 hours of exposure to xenon radiation compared with the 3.000 hours required by the EN 438-2 standard: 2005 Sect. 29.
- **Long-lasting against wood-eating pests (termites):** with a Grade 0 result (no sign of infestation) according to test EN 350-1: 1994.
- **High resistance to sharp changes in temperature and moisture** ( $-20^\circ\text{C}$  to  $80^\circ\text{C}$ ) without loss of mechanical properties or changes in appearance, according to EN 438- 2: 1995 Sect. 19.
- **Excellent dimensional stability.** See chapter 2.2.2. (pg. 48).
- **High impact resistance against hard objects** with a small or large diameter.



## Cleaning

- Easy to clean and maintain.
- The boards do not attract dust.



## Graffiti resistance

- The exterior non-stick chemical sheet that impregnates the **ProdEX** panels prevents aerosol paint from sticking permanently to the board.



## Fire-proof product (ProdEX IGN)

- All **ProdEX** boards can be supplied in a fire-proof format, according to EN 13.501-1 standard.
- This European standard provides the reaction to fire classification for all construction products.
- Construction combustible products can range from Class B to Class F, where Class B is the strictest of all classifications.
- Furthermore, the product may also hold an additional classification:
  - For smoke production: this can range from s1 to s3, where s1 is the strictest of the classifications.
  - For flaming droplets/particles: this can range from d0 to d2, where d0 is the strictest of the classifications.



## 1.4. Sizes and weight

The sizes and weight of the product are listed as follows:

Board size:

Length x Width  
2.440 mm x 1.220 mm

Thicknesses

3, 6, 8, 10, 12, 14, 16, 18, 20, 22 mm

Board weight:

Board thickness	3	6	8	10	12	14	16	18	20	22	(mm)
Weight / surface unit	4,05	8,10	10,80	13,50	16,20	18,90	21,60	24,30	27,00	29,70	(kg / m <sup>2</sup> )

(for dimensional tolerances see data sheet)

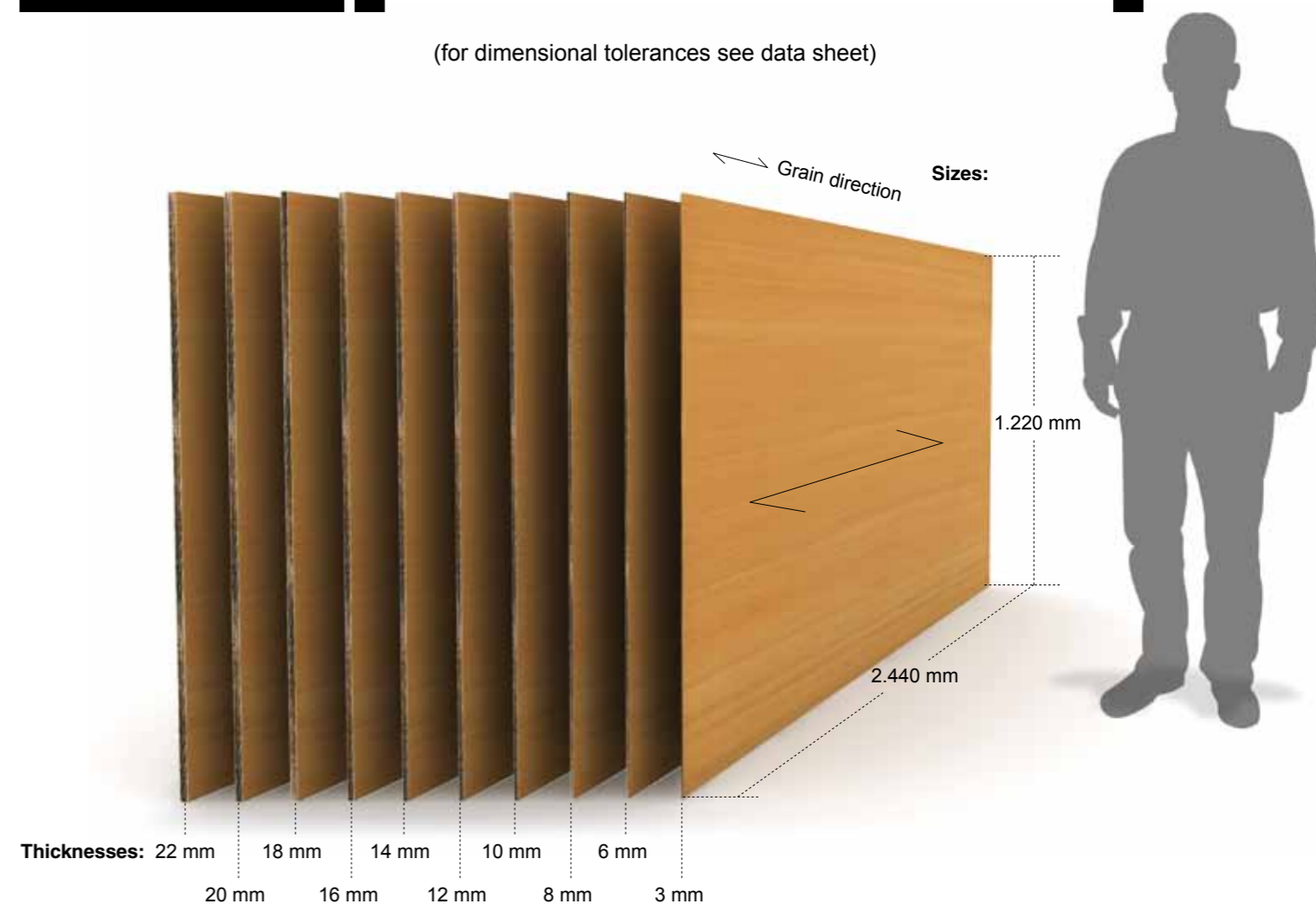



## 1.5. Colours

Each **Prodema** natural wood panel is unique and will exhibit differences in grain and colour within the same supply. **Prodema** carefully selects the wood veneers in an endeavour to ensure that the colour within a batch will be as homogeneous as possible.

As wood is a natural and dynamic product, the shade and grain may vary from those shown in the samples.

The shade of the edges can vary depending on the pressing process.



# Dark brown

## Rotary cut wood

### Ayous Veneer

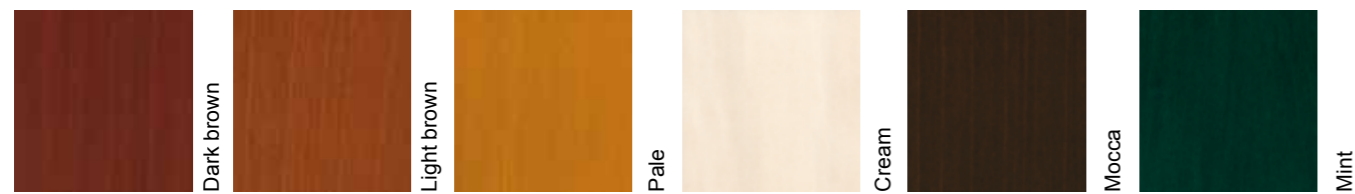

### Okume Veneer



All **ProdEX** finishes are Smooth finish (smooth).



# Light brown



# Pale



# Cream

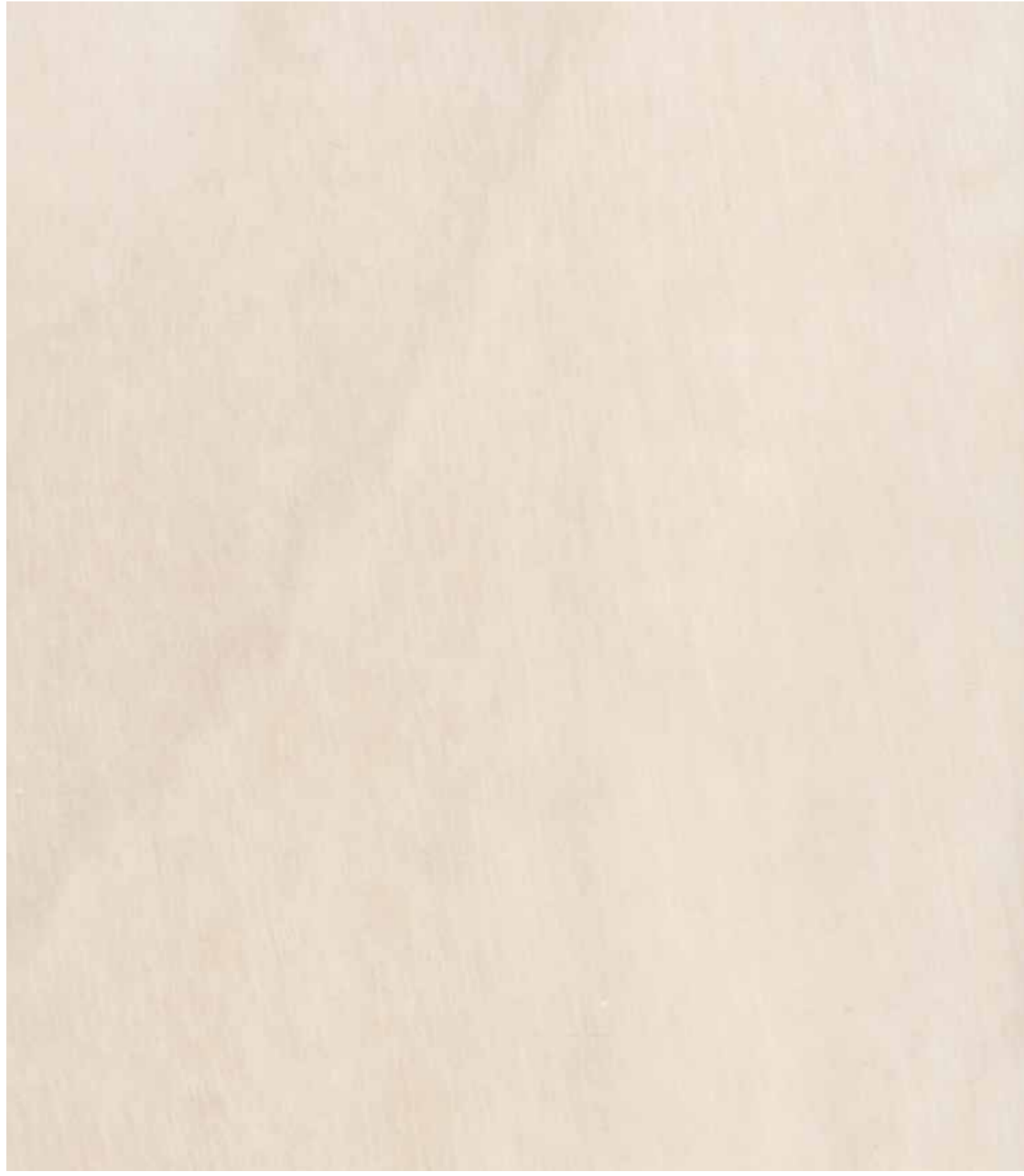

# Mocca



# Mint



# Deep brown



# Rustic



# Ice grey

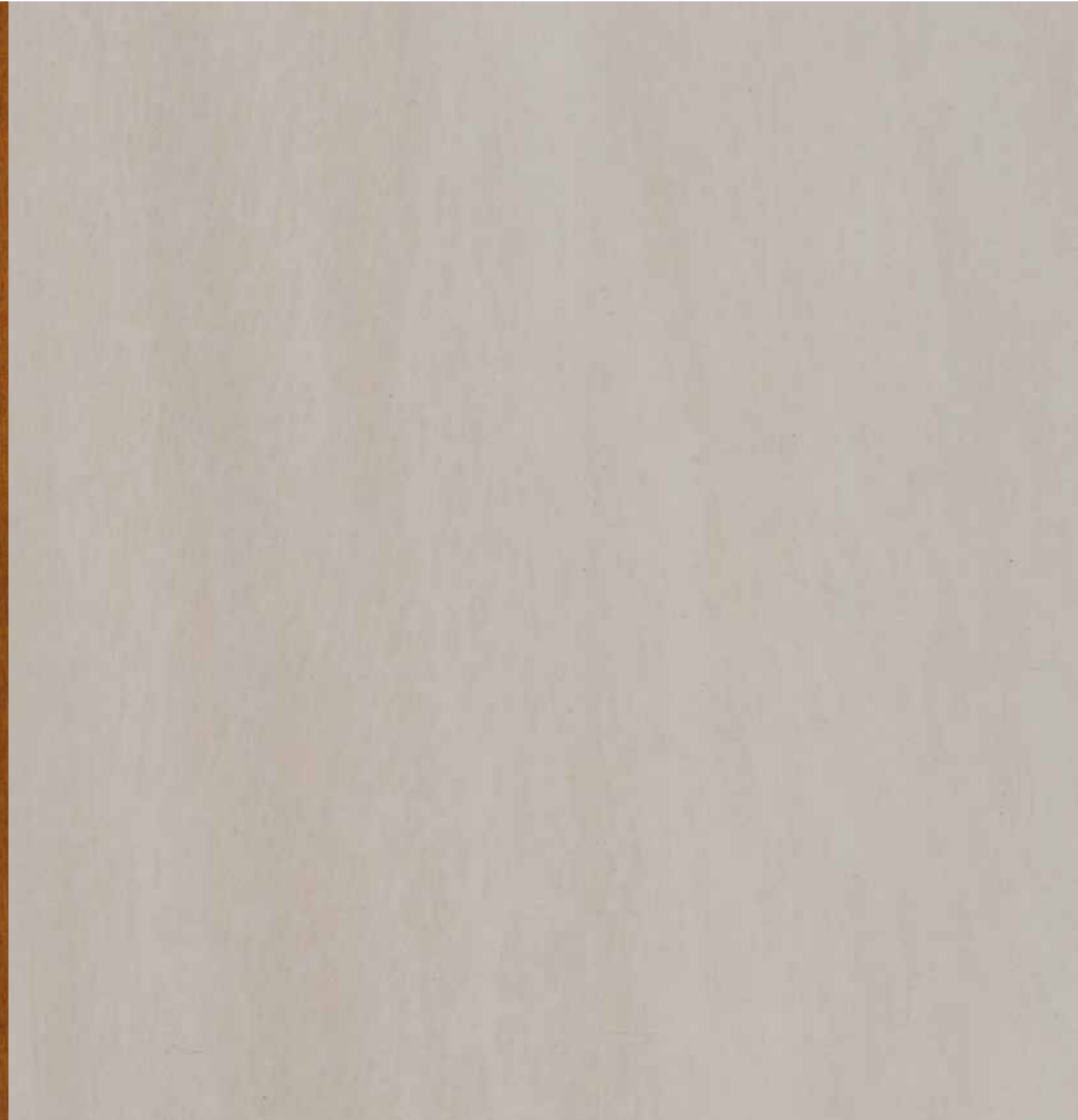

## 1.6. Technical characteristics

 <b>TECHNICAL DATA SHEET</b>		Doc.: FTPRODEX Rev.: 010 – Sep 2011 Page: 1/1		
MATERIAL:	THICKNESS:	SURFACE FINISH:		
PRODEX	6 – 22 mm	SMOOTH		
TESTS	RESULTS	PROPERTY OR ATTRIBUTE	MESURE UNIT	STANDARD
<b>1. INSPECTION REQUIREMENTS</b>				
Colour, pattern and surface finish	Due to the fact that wood is a natural product, each veneer may be considered as unique. Colour and structure differences are considered as normal. Singularities such as knots and resin inclusions are not considered as defects, but as a part of the décor. There are differences in light fastness performances depending on the wood species and the source of the wood.			EN 438-8 Part 5.2.2.3
<b>2. DIMENSIONAL TOLERANCES</b>				
Thickness (t)	± 0,40 ± 0,50 ± 0,60 ± 0,70 ± 0,80	6,0 ≤ t < 8,0 8,0 ≤ t < 12,0 12,0 ≤ t < 16,0 16,0 ≤ t < 20,0 20,0 ≤ t < 25,0	mm	EN 438-2 Part 5
Length and width	+ 10 / - 0	-----	mm	EN 438-2 Part 6
Edge straightness	1,5	-----	mm/m	EN 438-2 Part 7
Edge squareness	1,5	-----	mm/m	EN 438-2 Part 8
<b>3. PHYSICAL PROPERTIES</b>				
Dimensional stability at elevated temperature	0,30 0,60	Longrain Crossgrain	% max.	EN 438-2 Part 17
Resistance to impact y large diameter ball	≥ 1.800	Maximal height for which no visible surface cracking or imprint greater than 10 mm (t ≥ 6 mm)	mm	EN 438-2 Part 21
Tensile strength	> 60	Longrain Crossgrain	MPa	EN ISO 527-2
Determination of graffiti resistance	Level 4 Level 4 Level 1 Level 2	Permanent blue marker Spray red paint Wax black crayon Water based ink black marker	Cleanability level	ASTM D 6578:2000
<b>4. WEATHER RESISTANCE REQUIREMENTS</b>				
Resistance to UV light	≥ 3 ≥ 4	Contrast Aspect	Grey scale rating Rating	EN 438-2 Part 28 Rating according to EN 20105 – A02
Resistance to artificial weathering (including light fastness)	≥ 3 ≥ 4	Contrast Aspect	Grey scale rating Rating	EN 438-2 Part 29 Rating according to EN 20105 – A02
<b>5. CE SAFETY REQUIREMENTS</b>				
Reaction to fire	C-s2,d0	Euroclass t ≥ 6 mm	Classification	EN 13.501-1
Thermal resistance/Conductivity	0,261	Thermal conductivity (λ)	W /m K	EN 12664
Water vapour permeability	110 250	Wet cup method Dry cup method	μ	EN 438-7 Part 4.4
Resistance to fixings	> 2.000 > 3.000 > 4.000	Screw holding value for t = 6 mm Screw holding value for t = 8 mm Screw holding value for t ≥ 10 mm	N	EN 438-7 Part 4.5
Flexural strength	≥ 80 ≥ 80	Longrain Crossgrain	MPa	EN ISO 178
Flexural Modulus	≥ 9.000 ≥ 9.000	Longrain Crossgrain	MPa	EN ISO 178
Resistance to climatic shock	≥ 4 ≥ 0,95 ≥ 0,95	Appearance Flexural strength Elastic modulus	Rating Index Ds Index Dm	EN 438-2 Part 19
Density	≥ 1,35	Density	g/cm³	EN ISO 1.183
Resistance to wet conditions	≤ 5 ≥ 4	Moisture absorbed Appearance	% Rating	EN 438-2 Part 15

### ProdEX Fire reaction

#### NON Fireproof material (ProdEX)

Thickness ≥ 6 mm | Clas.: C-s2, d0 (according to EN 13.501-1)

#### Fireproof material (ProdEX IGN)

Thickness ≥ 6 mm | Clas.: B-s2, d0 (according to EN 13.501-1)

## 2. Mounting systems

### 2.1. Ventilated façade

It is essential to use a ventilated façade when mounting **ProdEX** panels. In order for this type of panel to perform correctly, it is very important that the differences in moisture and temperature between both sides of the panel are kept to a minimum. A ventilated façade has several advantages over a conventional façade:

- A ventilated façade provides us with waterproofing against rain and prevents water from penetrating into the air chamber.
- It evenly spreads the water vapour from the building's interior to the exterior.
- A ventilated façade generates constant air ventilation and prevents moisture from getting trapped and dampening the insulation.



- It reduces movements of the building's structure due to the fact that, as it ventilates the façade, temperature changes are reduced.
- It reduces heat bridges to a minimum.
- It achieves an energy saving of between 5 and 10%, as it absorbs less heat in summer and disperses less heat in winter.
- Easy to mount and dismantle, and it is a good solution for restorations.
- It improves sound insulation.

WATERPROOF AGAINST RAIN



IMPROVES REACTION AGAINST FIRE



IMPROVES SOUND INSULATION

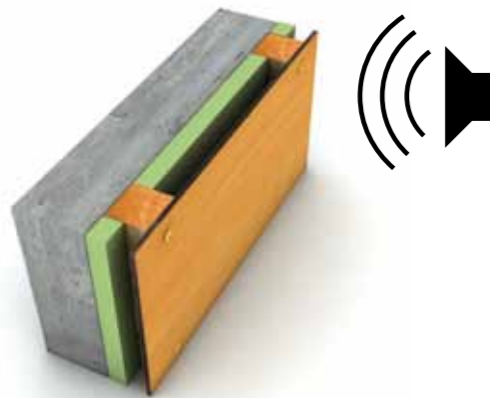

THERMAL - HEAT INSULATION

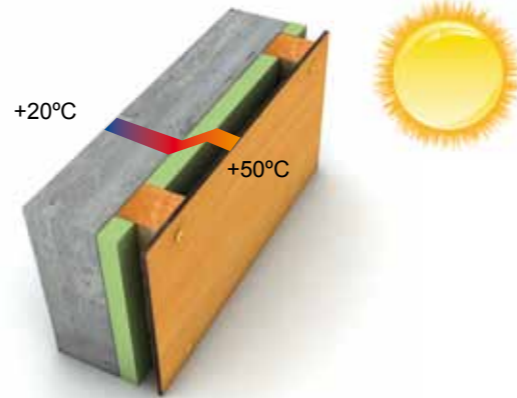

THERMAL - COLD INSULATION

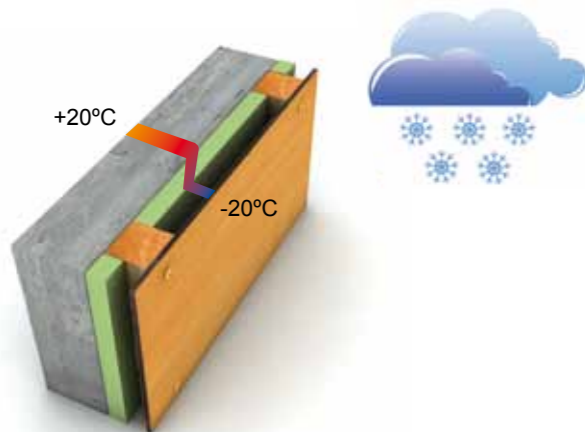

In order for the **ProdEX** ventilated façade to function correctly, both sides of the board must be exposed to the air. To do so, it is important to bear in mind these main points:

- The air space between the panels and the insulation or closure must be at least 20 mm, and all national or local legislation indications must also be observed. For example, the Technical Building Code (CTE) in Spain indicates a space of 30 mm to 100 mm.
- Leave an opening of at least 20 mm in the lower and upper part of the façade, as well as in the doors and windows, so that air can circulate vertically.
- We recommend you use only vertical strips, as they do not interfere with air circulation. Should you use horizontal strips that make vertical ventilation difficult, there must be perforations in said strips to allow 20 cm<sup>2</sup>/m of ventilation for coverings on façades with a height of up to 1 metre, and 50 cm<sup>2</sup>/m for coverings on façades with a height of over 1 metre.

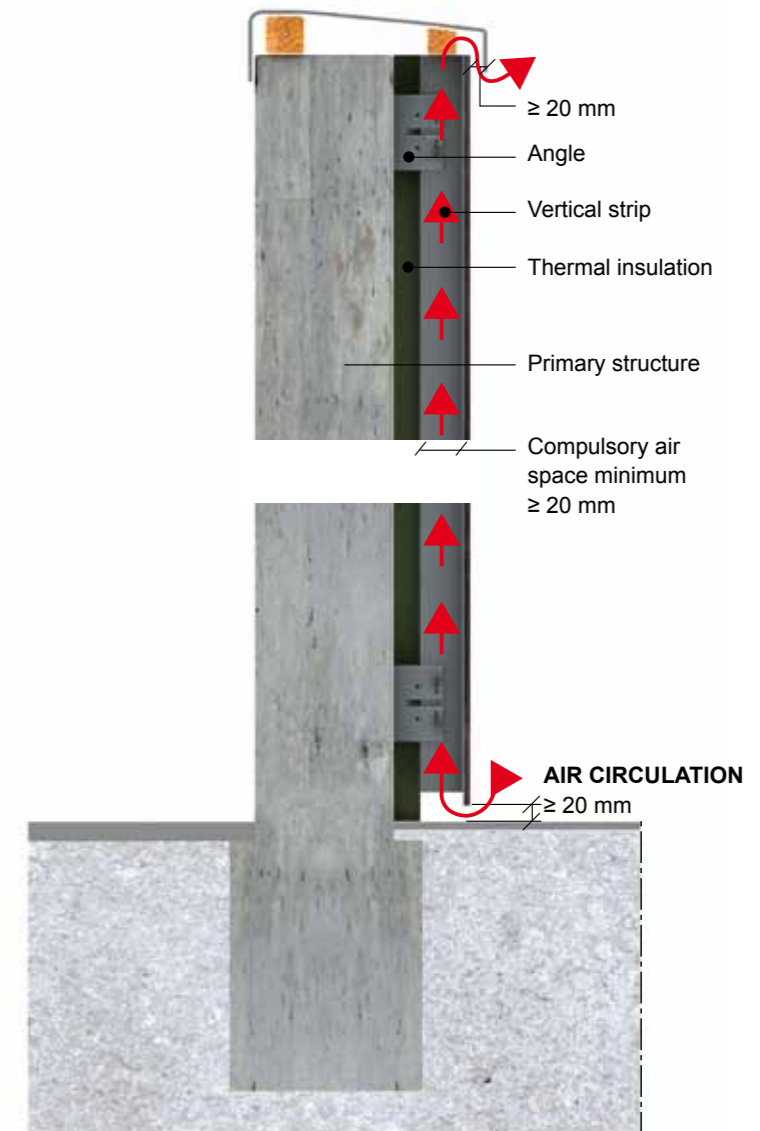

## 2.2. Joints and dimensional stability of the panel

### 2.2.1 Expansion joints:

An expansion joint must be taken into account between the panels of 6-8 mm. The joint enables the **ProdEX** panels to have the necessary freedom of movement through the materials' expansion and compression, which is caused by movements of the material as a result of changes in temperature and moisture.

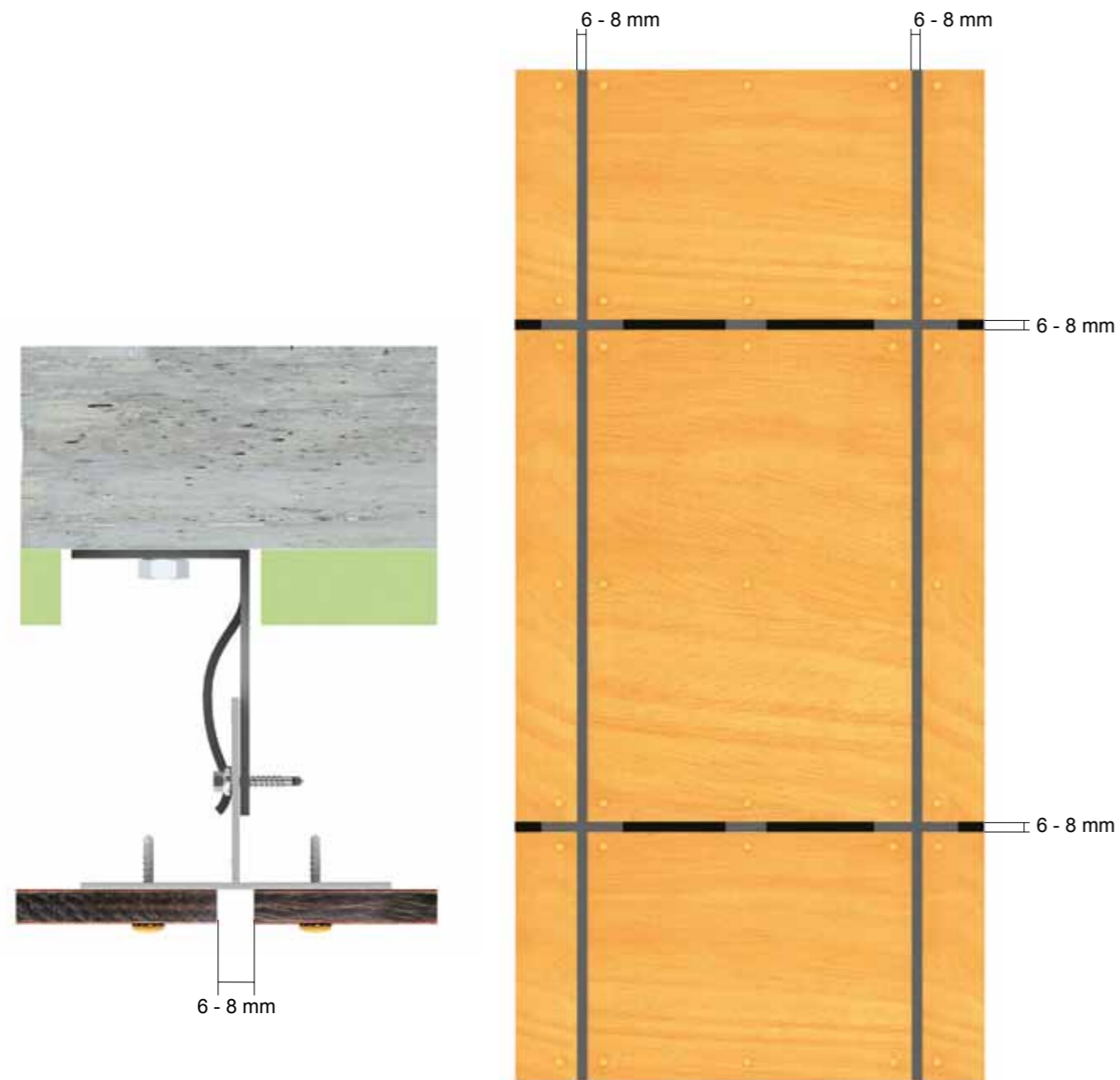

### 2.2.2 Dimensional stability:

**ProdEX**, because it is covered in natural wood, experiences small dimensional variations as a consequence of changes in environmental moisture and temperature. The maximum dimensional variation in a longitudinal direction is 0.30% and in a transversal direction to the board is 0.60%. These small dimensional variations do not affect the aesthetics or the functionality of the boards. For this reason it is essential to bear in mind the expansion joints indicated by **Prodema**.

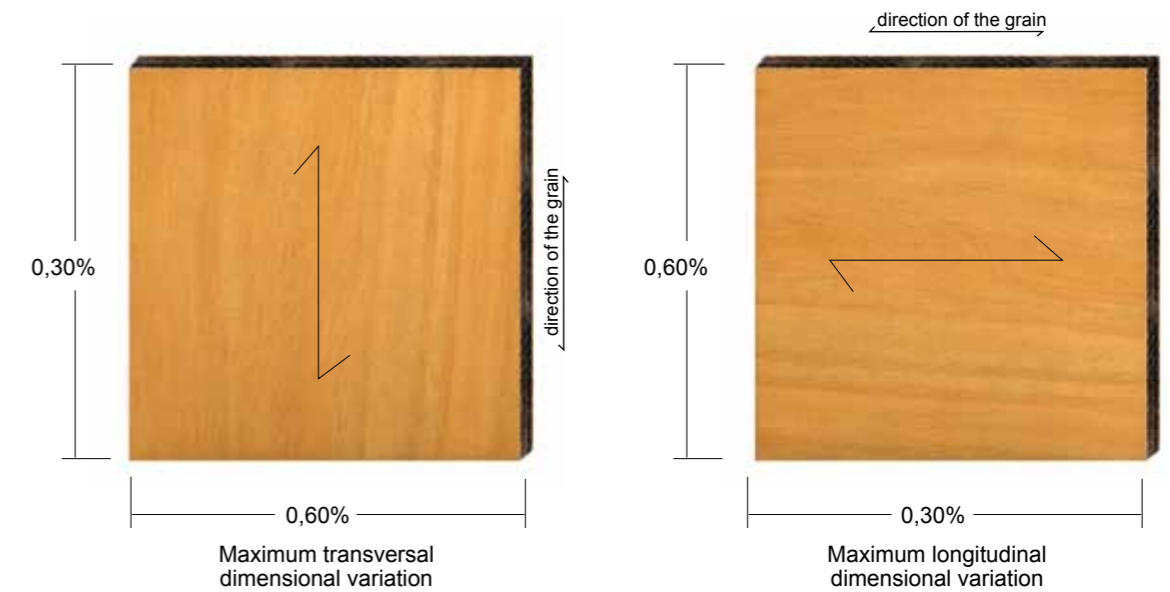

**ProdEX** is a water-resistant material; resistant to vapour, water, snow and ice. However, you are advised not to immerse the edges in water permanently or for a prolonged period of time because it could lead to the appearance of areas of a darker colour on the edge of the board's surface.



## 2.3. Sub-structure

### 2.3.1 Different types of strips and auxiliary elements:

Different strip materials may be used to fix the **ProdEX** panels:

- Treated wood: pine, larch, tali, etc.
- Metal: aluminium and galvanised steel, or occasionally stainless steel.

The choice of metal strip depends on the area on which the panels are to be applied and on the required characteristics.

- Aluminium: for wet or moist areas, sea environments and corrosive atmospheres. In highly corrosive environments, an anodised layer is usually applied to increase resistance.
- Galvanised steel: for wet or moist areas, non-corrosive atmospheres and non-sea environments. This material has better mechanical properties than aluminium.

The most common strips for **ProdEX** façades are the following:

- Wood: square or rectangular profile.
- Aluminium: wide variety of forms (see chapter 4 - Accessories). (Pg. 73).
- Galvanised steel: "U", "Z", "L", omega and tube profiles.

To get around the irregularities due to plumbing curvatures, adjustable auxiliary elements (angles, wedges, etc.) are used.

### 2.3.2 Minimum points of support per panel:

**Prodema** recommends that each panel is supported by the maximum surface of sub-structure possible for all mounting systems.

The panels should be supported by a **minimum of three points, both vertically and horizontally**, observing the diagrams on this page. The maximum distance between fixings described later in this catalogue should also be observed.

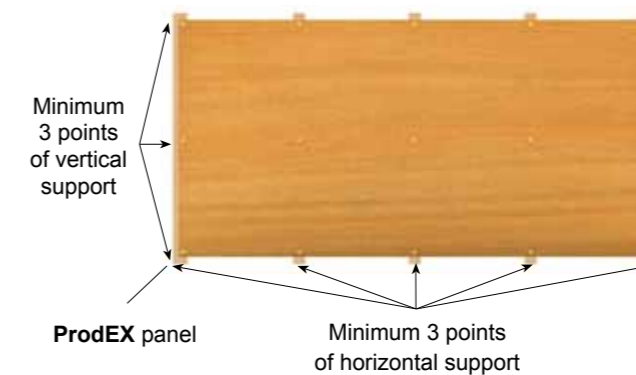

As an exception, **for pieces between 150 and 300 mm**, two points of support in the same direction are sufficient.

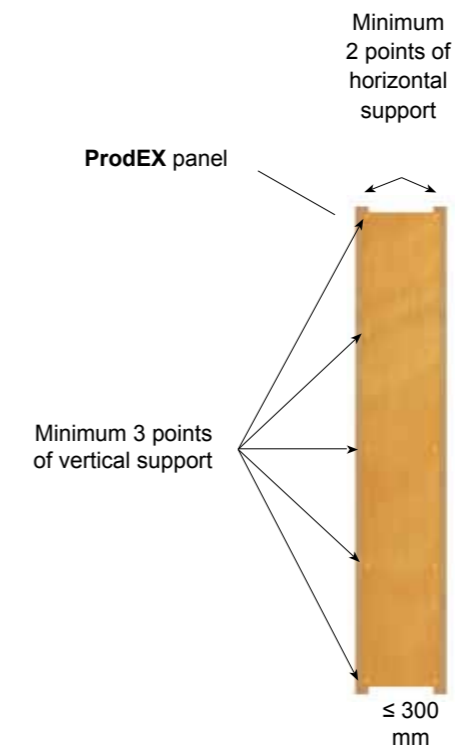

### 2.3.3 Anchoring to the façade:

The strips must be fixed to the façade using suitable fixing elements according to the façade material and the strip material.

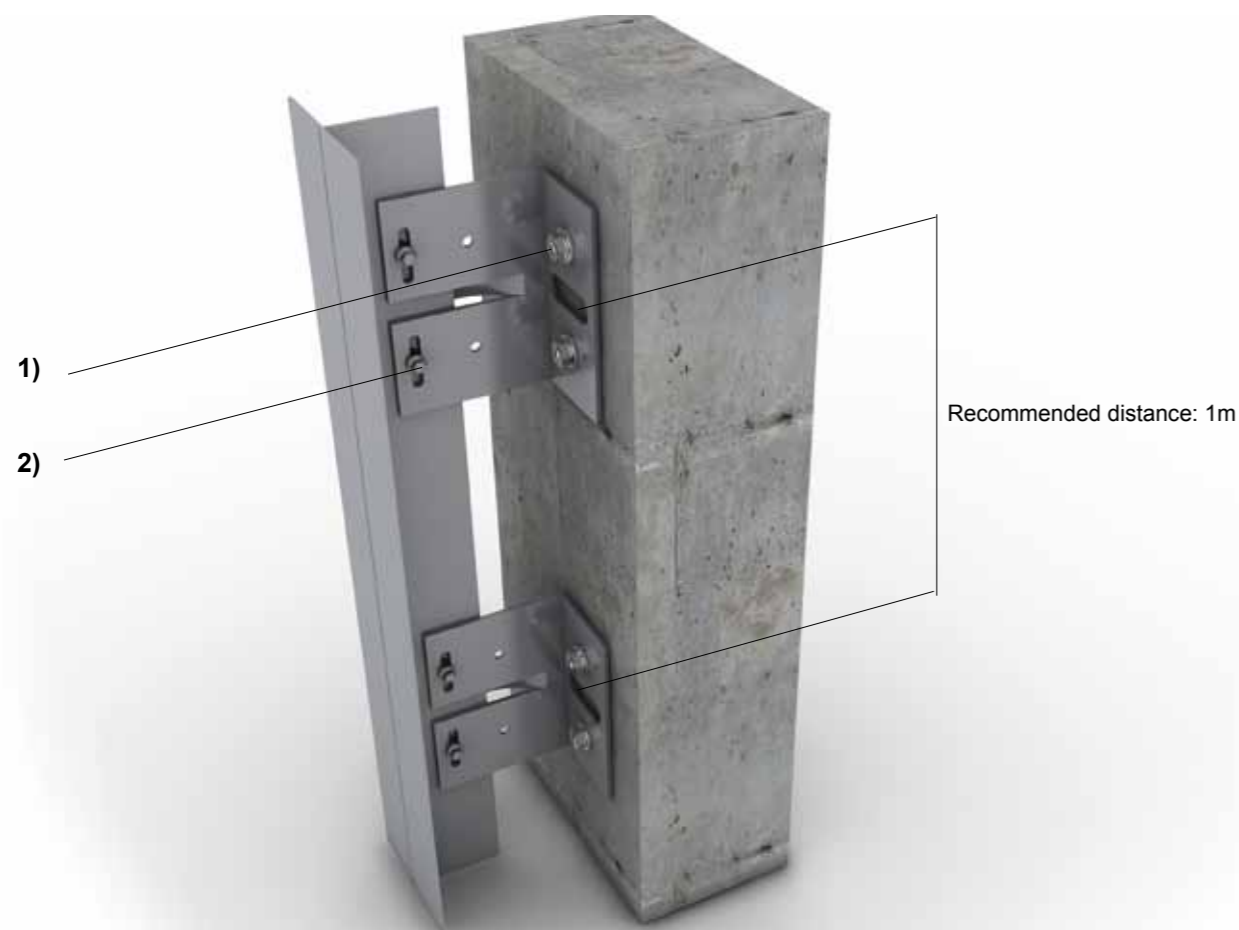

- 1) The angle brackets are fixed to the façade with screws and their corresponding wall plugs (made of steel or nylon).
- 2) The strip is fixed to the angle bracket support using austenitic stainless steel self-drilling screws.

For further information on accessories, see chapter 4. (Pg. 73).

## 2.4. Types of fixing

**Prodema, has two types of façade fixing systems:**

- Exposed fixing with screws or rivets.
- Concealed fixing. The concealed fixing can be:
  - With hanging profiles.
  - Glued.

### 2.4.1 Exposed fixing:

A typical characteristic of this type of installation is the fixing of **ProdEX** panels using exposed rivets or screws. These screws and rivets\* are made of metal and you can order them to be lacquered in the same colour as the panel.

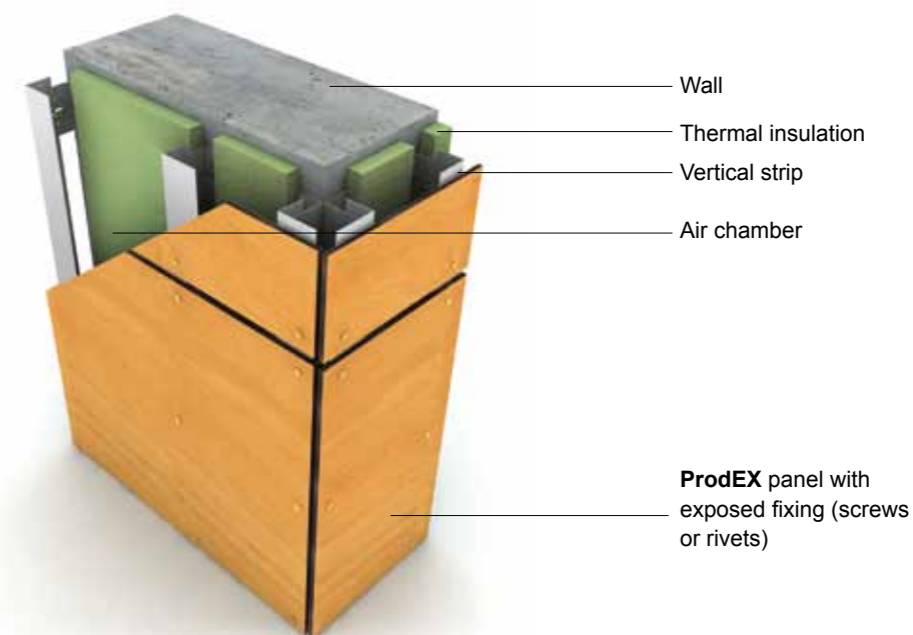

### • Distances between screws or rivets\* on one single panel

The distance between the screws or rivets\* both horizontally and vertically on a single line depends on the thickness of the panel:

THICKNESS (mm)	DISTANCE BETWEEN POSTS (mm)
3**	≤ 300
6**	≤ 400
8, 10	≤ 600
12	≤ 800
14	≤ 1.000
≥ 16	contact <b>Prodema</b>

\*\*Only for special applications. Contact **Prodema**.

For hole diameter see chapter 3.3.2.

Never use countersunk screws to fix **ProdEX**.

\*The rivets are only used with metal sub-structures, not with wooden sub-structures.

• Distances between screws and rivets\* and the corner of the panel

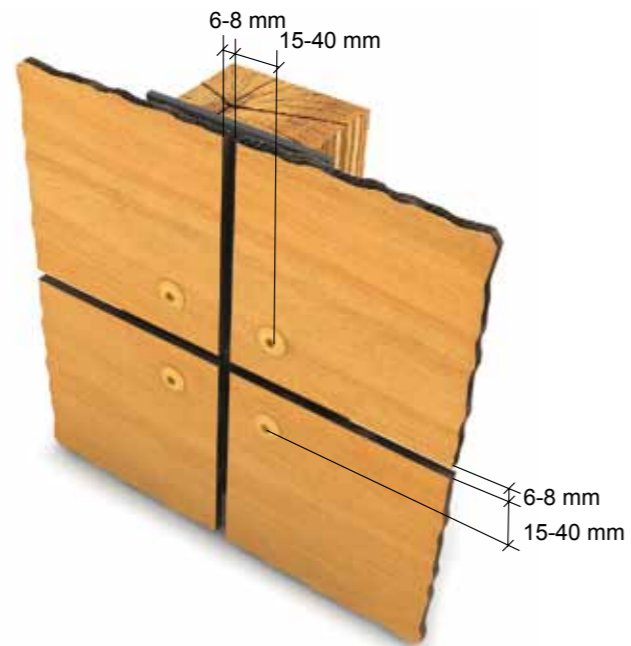

The screws and rivets\* on the corners of the panel must be between 15 and 40 mm from the edge of the panel.

• Recommendation for screws or rivets\* for panel fixing

- For wooden strip:

Screw: SFS-TW-S-D12 - 4.8 x 38 (lacquered or unlacquered).  
For further information, see chapter 4.3.2. (Pg. 75)

**EPDM**  
When the panels are installed with wooden strips, it is advisable to include a strip of **EPDM** to protect the strip.



\*The rivets are only used with metal sub-structures, not with wooden sub-structures.

- For metal strips:

· With screw:

Screw: SFS-SX3-L12-5.5 x 32 (lacquered or unlacquered).  
For further information, see chapter 4.3.1. (Pg. 75)

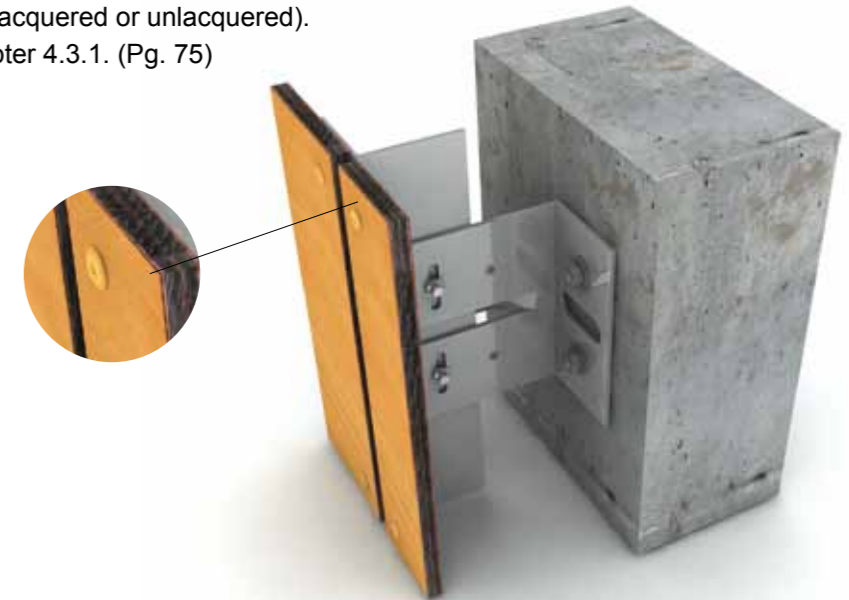

· With rivet\*:

Rivets\*:  
SFS- AP16-50160 (lacquered or unlacquered).  
SFS- AP16-50180 (lacquered or unlacquered).  
SFS- AP16-50210 (lacquered or unlacquered).

For further information on rivets, see chapter 4.3.1. (Pg. 75)

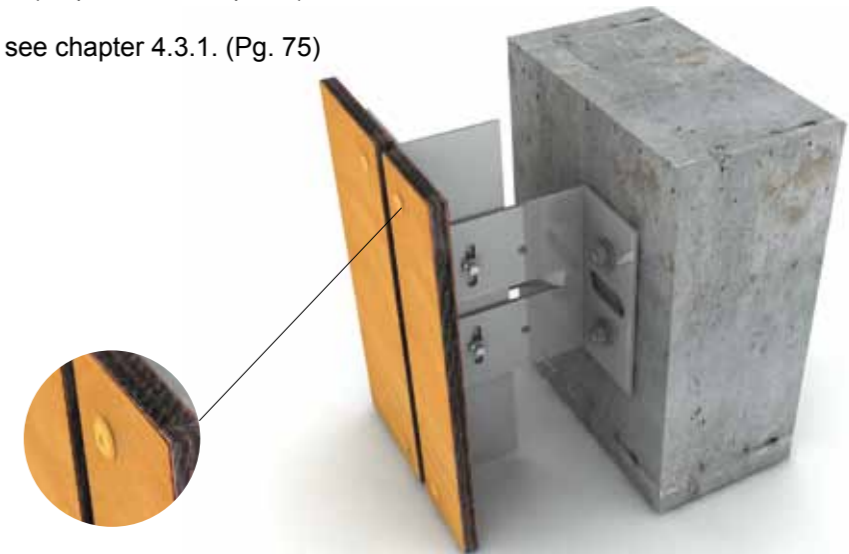

\*The rivets are only used with metal sub-structures, not with wooden sub-structures.

### 2.4.2 Concealed fixing with hanging profiles:

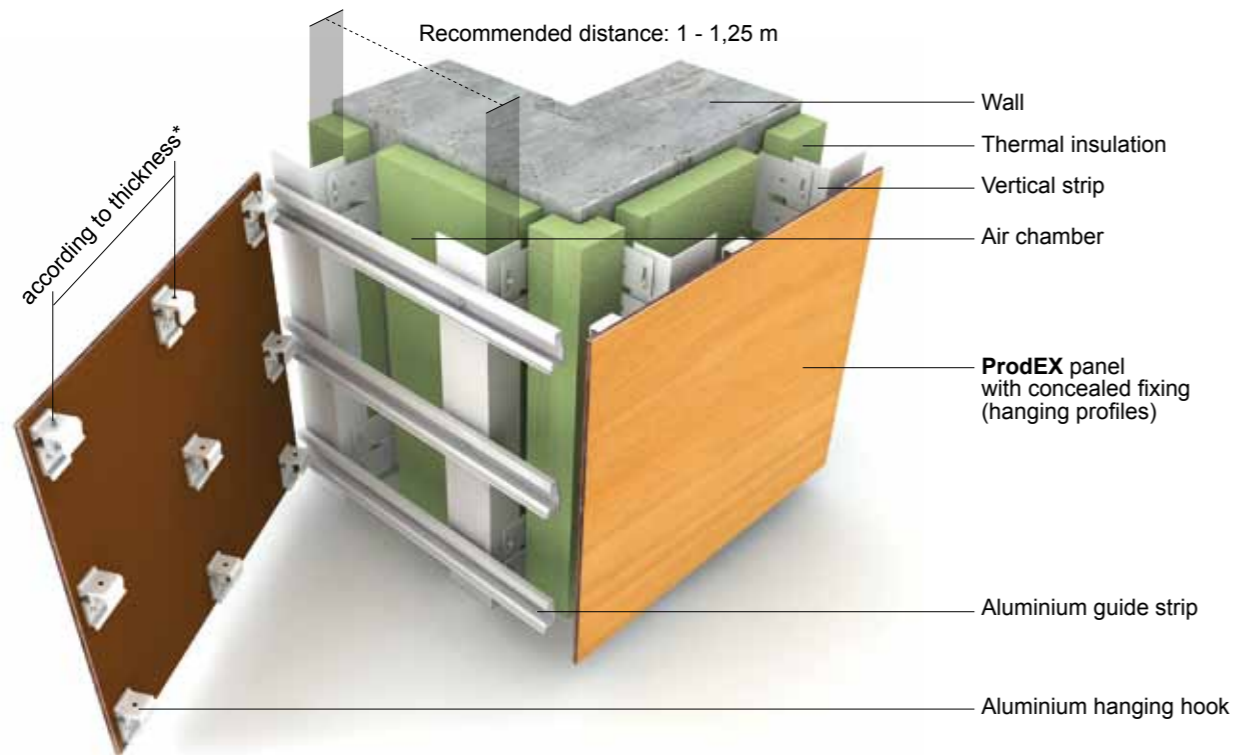

Concealed fixing with hanging profiles enables the **ProdEX** panels to be installed using screws that cannot be seen from the outside. This fixing system is only possible when using panels with a thickness of 10, 12 and 14 mm.

This system comprises aluminium profiles (guide profile) and hanging hooks.



For further information on accessories, see chapter 4.

\* See table on page 57.

The guide profiles are horizontal posts that are placed on top of the primary aluminium sub-structure. To fix the guide profile to the sub-structure, self-threading screws are used.

The hanging hooks are aluminium pieces that are fixed to the back of the boards with Panel TB-A2 TX 30 Screws.

Given that **ProdEX** material is a very hard material, you will have to make a blind perforation on the board beforehand so as to be able to screw in this screw. The hole must have a diameter of 5 - 5.1 mm and it must be 1.5 mm deeper than the screw once it has been adjusted. The distances between these screws must be measured exactly and they must be at a certain height from the edge of the board.



The main difficulty in the installation of panels with hanging profiles lies in the alignment of the board at the right height. The hanging hooks allow a regulating screw to be added, which allows the panel to be easily levelled at the right height once the board is fixed to the façade.

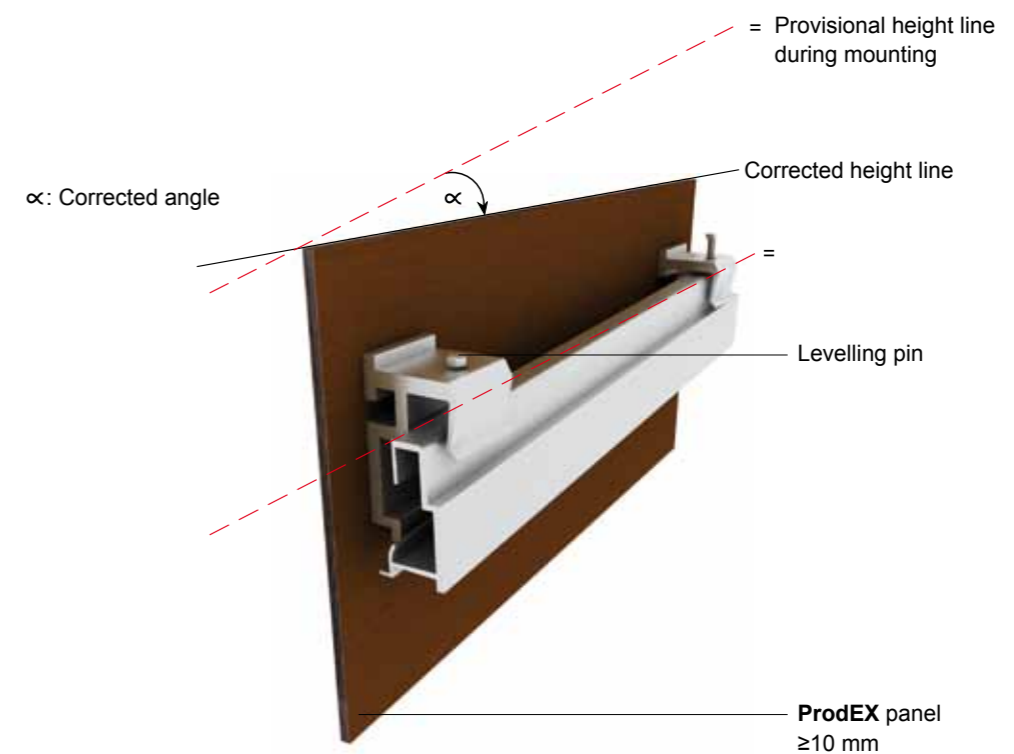

For further information on screws, see chapter 4.

**• Mounting of the horizontal guides**

The aluminium guide strips are placed horizontally onto the aluminium sub-structure distanced according to the panel's thickness\*, making sure that there are at least three aluminium guide strips per panel.

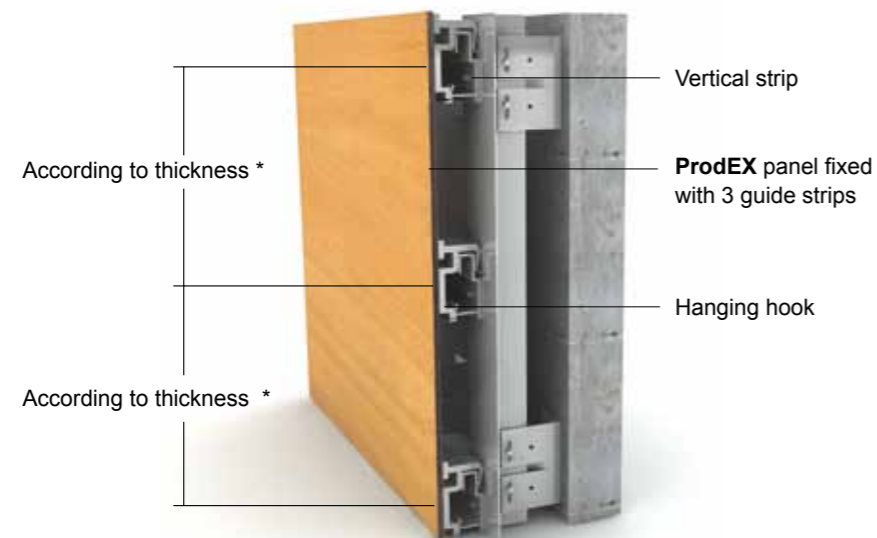

\* See table below.

As an exception, for pieces between 150 and 400 mm, two guide strips are sufficient. The distance between the axes of the strips must always be  $\leq 300$  mm.

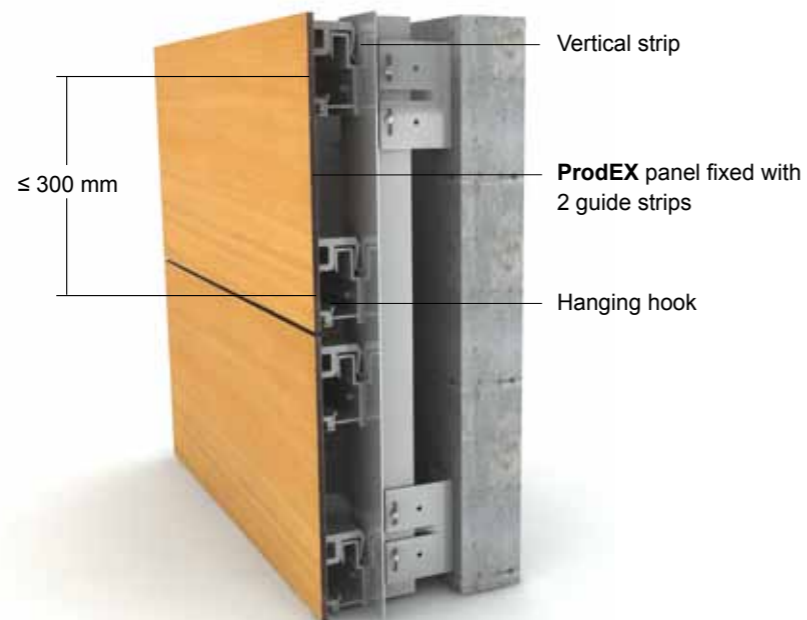

**Table for concealed fixing with hanging profiles:**

THICKNESS (mm)	DISTANCE BETWEEN FIXINGS (mm)
10	$\leq 600$
12	$\leq 800$
14	$\leq 1.000$

**2.4.3 Concealed fixing with gluing system:**

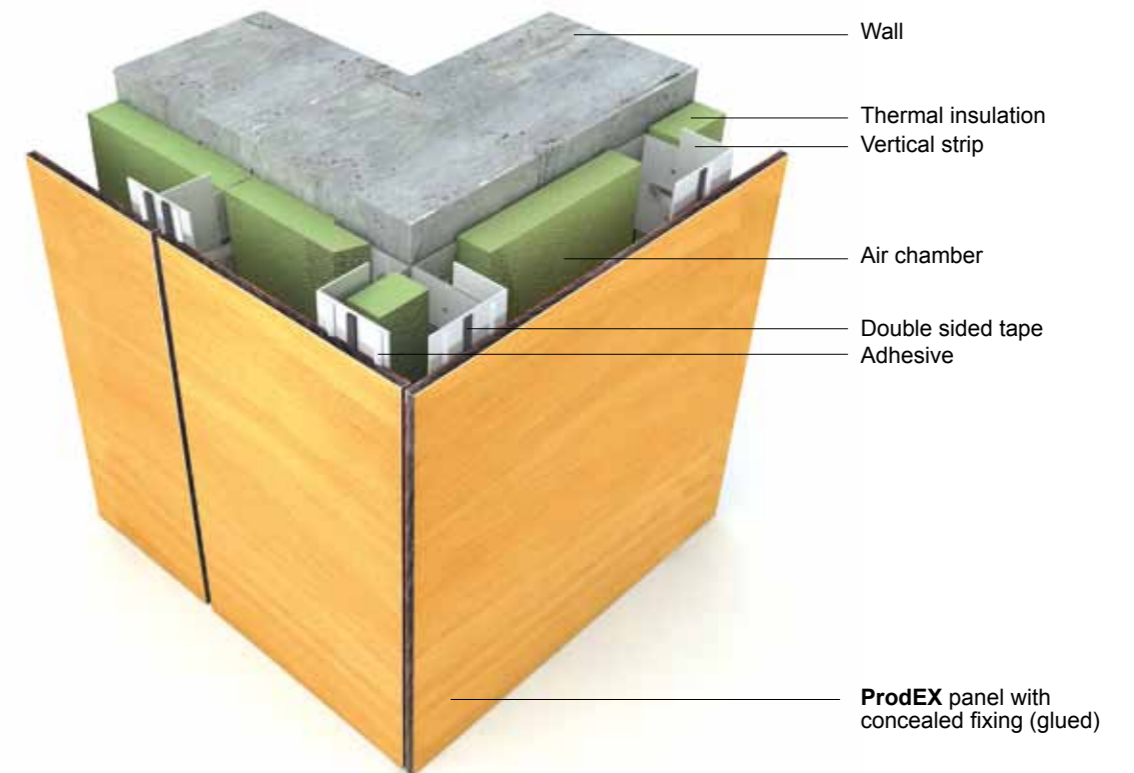

The thickness to use for the façade gluing system is 8, 10 and 12 mm.

Fixing using the gluing system is a delicate process which requires an appropriate procedure to be strictly followed, always respecting the gluing manufacturer's explicit instructions.

**Table for concealed fixing with glue:**

THICKNESS (mm)	DISTANCE BETWEEN FIXINGS (mm)
8 - 10	$\leq 400$
12	$\leq 600$

• **Indications for the gluing procedure**

1.) Carefully clean the **ProdEX** panel area to be glued using a brush, air or a special solution provided by the same manufacturer as the adhesive.



2.) Sand the strip on the surface that supports the panel. Wooden and aluminium strips must be sanded and you must ensure that the strip is thoroughly dust-free and that the gluing surface is completely dry. Steel strips should not be sanded, so as not to damage their rust protection layer and any grease on them should be cleaned off with a solution.

3.) Shake the primer well before use and apply it to the sanded, clean and dry areas on the panels and strips, taking care not to prime any further than the area to be glued in the following 6 hours. You should use a specific primer for each material (wooden strip, metal strip, panel, etc.) as indicated by the adhesive manufacturer.



4.) Follow the instructions regarding the primer's minimum and maximum drying times according to the printed material. After drying, proceed with the gluing procedure.



5.) Stick two double-side adhesive tapes in a constant line parallel to the length of the strip and in its centre, without yet removing the protective cover paper on the tape's surface.

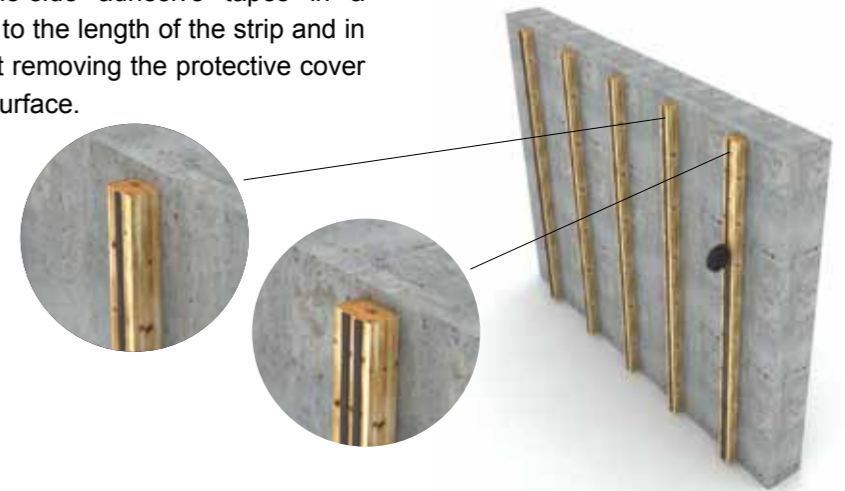

6.) Apply the bead of one-pack adhesive to the strip in the area where the **ProdEX** panel is going to be pressed on. The adhesive must be applied with a hand or air gun, using a special nozzle that leaves a triangular-shaped bead when seen as a section. You must always make sure that the areas of adhesion are neither damp nor dirty.

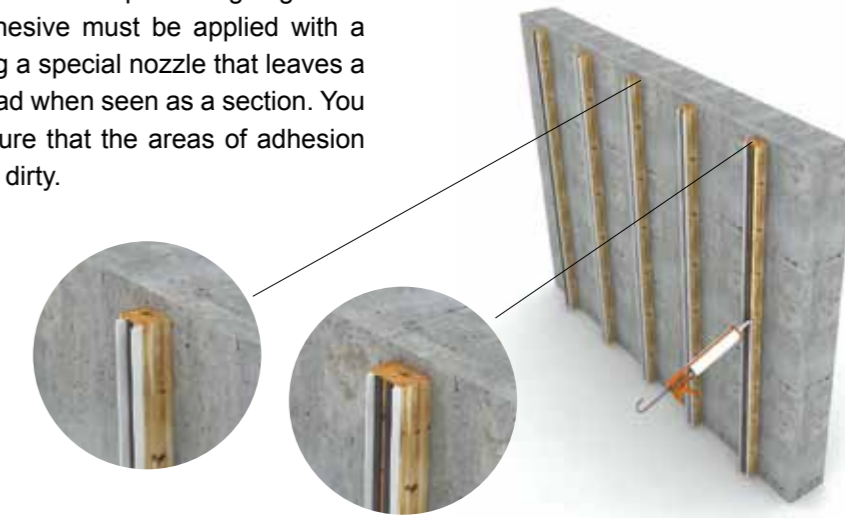

7.) Remove the adhesive tape's protective cover paper.

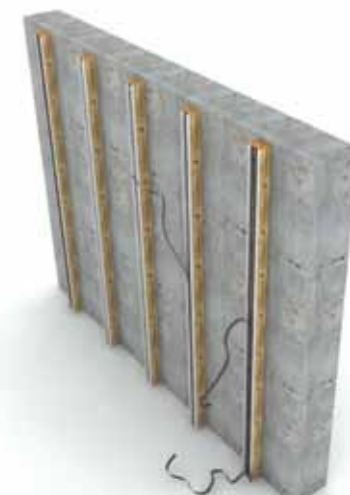

8.) After the first 10 minutes of applying the adhesive, carefully put the panels in place, taking care not to press too hard as this could cause the adhesive bead to spread too much and the façade would be left uneven. With the help of the double sided adhesive tape, the panels will be held tight on their three dimensions in the required place on the strip.



9.) We recommend you fix the boards with the help of several ties (fastened to the strips with screws), just to hold them together, not to force the boards into an incorrect position on the strip. These ties can be removed once the adhesive has polymerised, and this time period will depend on the environmental moisture level (between 17 and 24 hours).

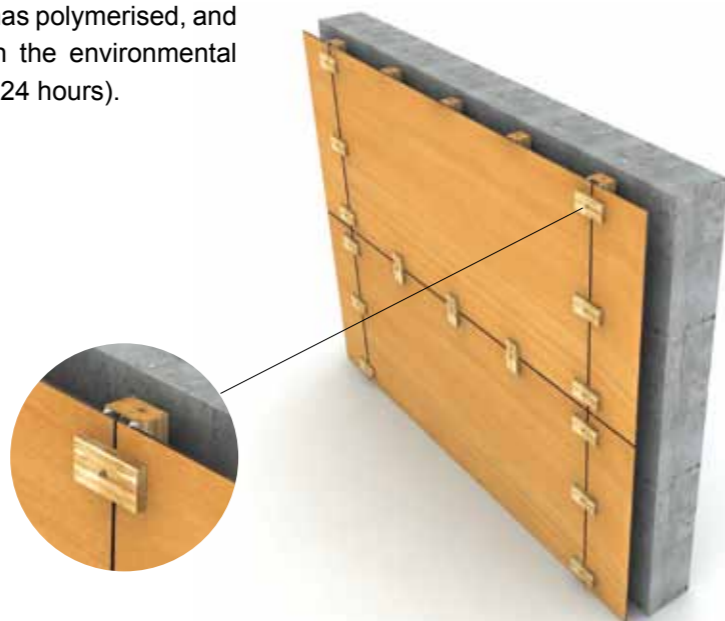

This gluing process by **Prodema** is a brief and general indication that by no means replaces the gluing manufacturer's full instructions, which explain each case in particular.

## 2.5. Solutions to corners

**ProdEX** can be machined on site in order to create all types of rivets that are usually used with wood, which means that they can be quickly and easily assembled onto any type of surface.

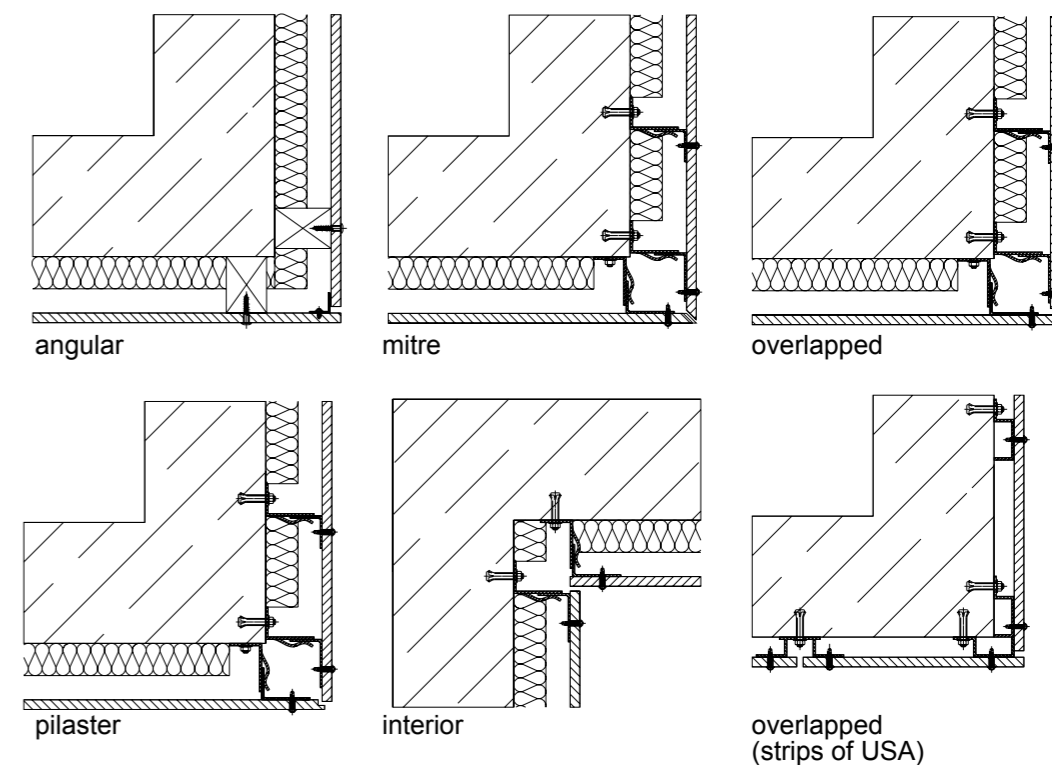

**Prodema** does not recommend using tongue-and-groove panel systems for exterior façades. This system is fixed with countersunk screws that do not allow the panels to move, and besides, they are only screwed down on the groove perimeter and not on the tongue perimeter, which is insufficient for the **ProdEX** panels to function correctly according to our recommendations.

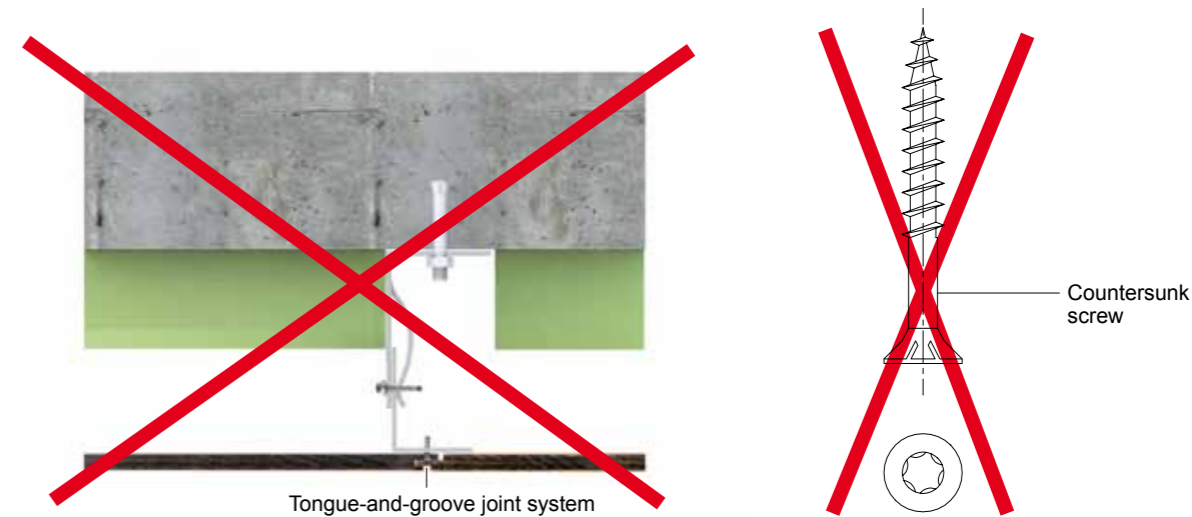

## 2.6. Unusual façades

ProdEX material also makes it possible to create unusual façades, such as:

### • Façades with unique modules



Silver City - Housing State  
G. Milusheva, V. Pernova (Bulgaria)

### • Curved façades

ProdEX material is sufficiently flexible to enable it to adjust to a curved sub-structure and be installed in the required position. In order for the material to adjust perfectly to the curvature, and to ensure that the board's tension is irrelevant for the façade once it has been finished, we would recommend a few factors that should be taken into account during the mounting stage:



Kingsway  
MBLA Architects + Urbanists - Lancaster (UK)

The panels for curved façades shall only be fixed using the exposed fixing system with screws or rivets.

The panels shall only be curved along the direction of the grain (see image).

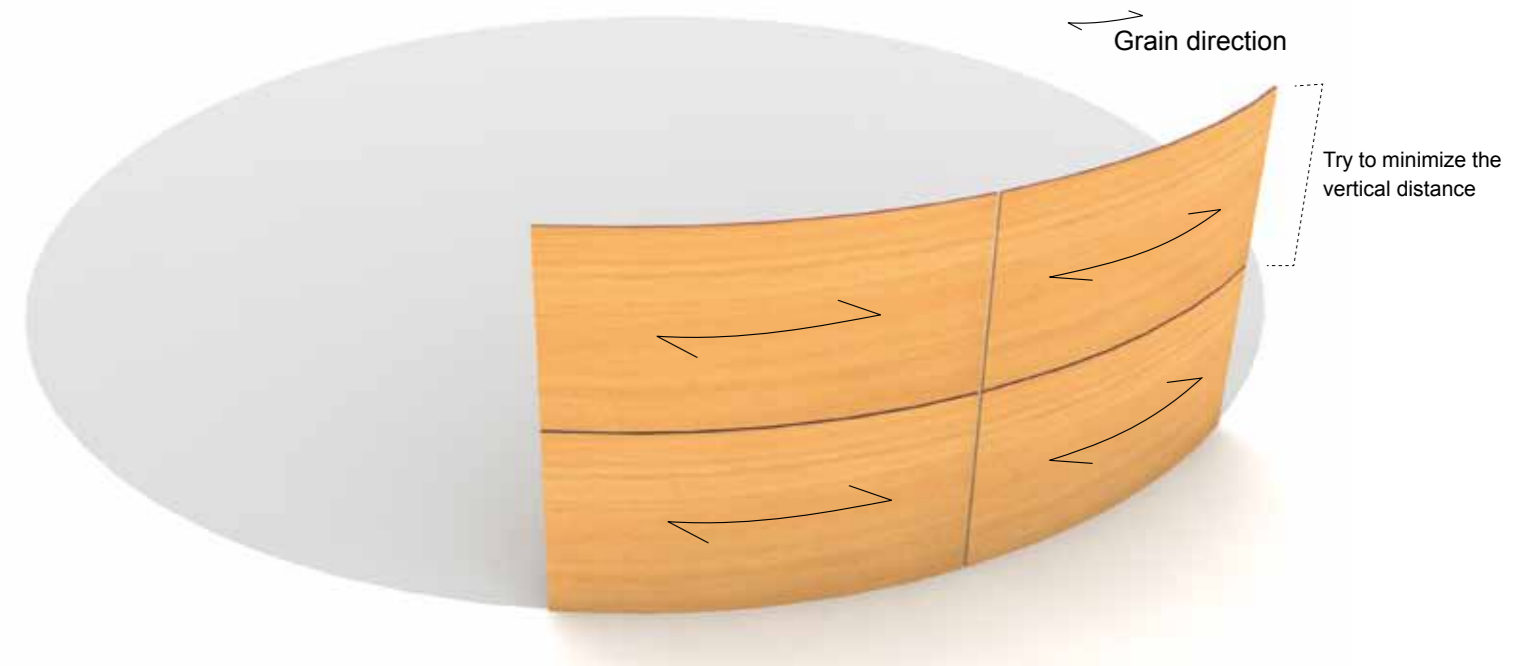

### - Board thickness:

The thickness of the board will be selected according to the attached table.

RADIO OF CURVATURE REQUIRED IN THE PROJECT	THICKNESS OF ProdEX PANELS TO BE USED	DISTANCE BETWEEN STRIPS
< 1,00 m	We recommend you use polygonal structures and do not curve the material	--
1,00 m – 5,00 m	3 mm*	≤ 150 mm
5,00 m – 10,00 m	6 mm*	≤ 300 mm
10,00 m – 20,00 m	8 mm	≤ 400 mm
> 20,00 m	10 mm	≤ 450 mm

\*Only for special applications. Contact **Prodema**.

### - Material fixing distances between vertical posts:

It is very important to bear in mind that **ProdEX** boards fixed in curved areas must be fastened and supported on many more strips than the sub-structure recommended for straight façades (see table on this page).



## 3. Product care and handling

### 3.1. Transport

To transport the **ProdEX** by **Prodema** boards for covering façades, you must use stable, flat pallets that are at least of the same size as the board.

To prevent any possible damage to the decorative layer due to rubbing, you must ensure that the boards do not rub against each other.

### 3.2. Storage

During storage, the boards must be protected from damp, heat, dirt and any possible damage, and at all times you should prevent the boards from becoming distorted, as the damage caused is irreversible.



The panels must be stored in a closed, ventilated place, at an approximate environmental temperature of 10 - 25 °C and an approximate level of air moisture of between 30 and 70%. After placement and storage, the (metallic) bands from the transport packaging must be cut and removed. In horizontal storage, the boards must be kept flat and supported along their entire surface area. This is the most recommended storage method.

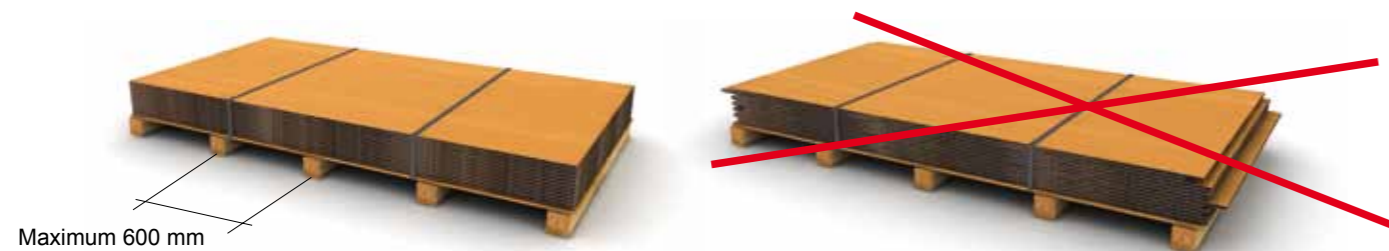

Maximum 600 mm

**It is prohibited to store panels vertically.**

The floor that supports the pallet must be free of any materials that could damage them.

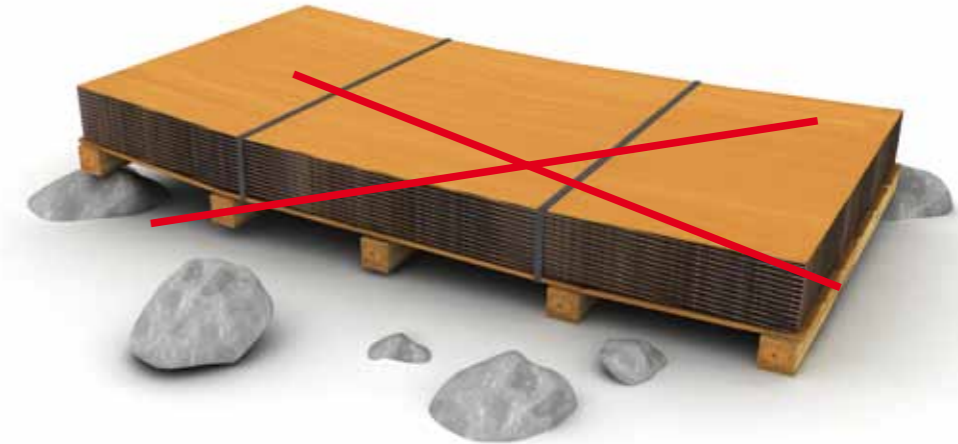

**Prodema** will send the boards on a pallet. A protection layer or sheet shall be placed between the pallet and the bottom board, and the boards must be protected with a PVC film.

The storage time should never exceed **five months** as from the date of issue indicated on the delivery note.

### 3.3. Machining

#### 3.3.1 Cutting recommendations:

Before preparing a board for modules, verify its perpendicularity, size and straightness.

The exterior panels must be cut using well-sharpened, hard tools (tungsten carbide/Widia), and at all times you should prevent said tools from heating.

**• Type of disc blade**

- Wood-cutting saw blades with hard material (Widia tip).

Approximate parameters for saw blades, according to the type of tool:

DIAMETER (mm)	TEETH (z)	SPEED (rpm)	BLADE THICKNESS (mm)	TYPES OF TEETH
300	48	4000-6000	3,2	alternating teeth
250	40/48	4000-6000	3,2	slanted (1) and flat tooth
190	30	3000-3500	2,2	trapezoidal (2).

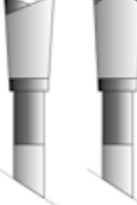

**• Placing the board**

The cutting blade must always enter from the board's good side.

- Table-mounted saw: the visible side of the board must be facing upwards.
- Hand-held saw: the visible side of the board must be facing downwards.

**Height of the cutting blade:**

In order to achieve a clean cut on the exposed side, we recommend the cutting blade stands out approximately 1-2 cm from the material to be sawn.

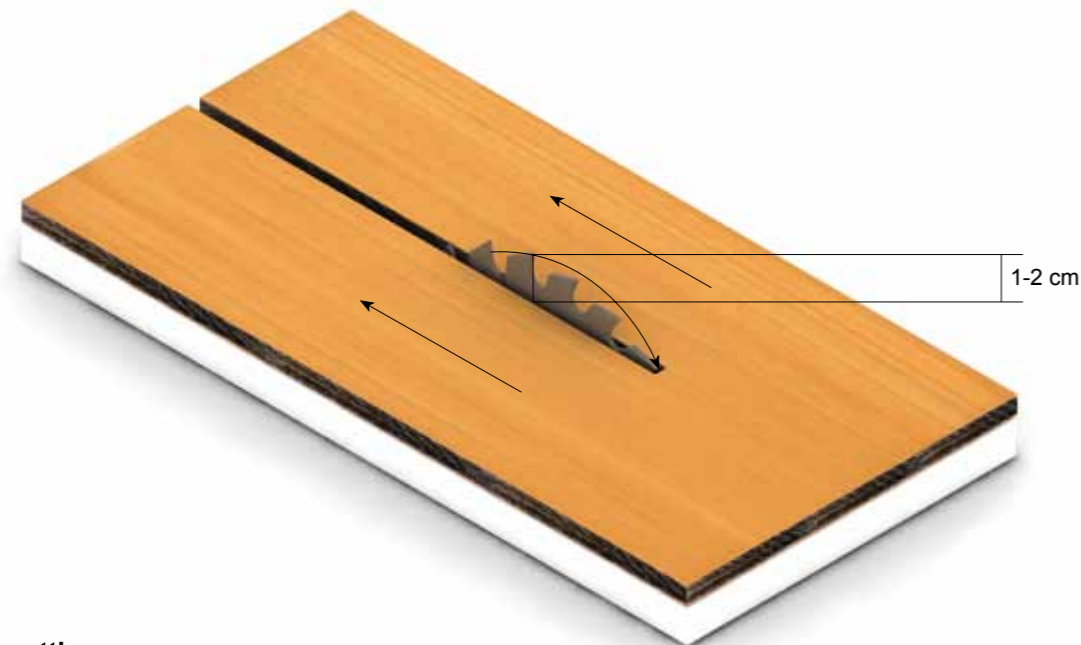

**After cutting:**

After machining (sawing, drilling, milling, bevelling, sanding, and maybe polishing) there is no need for the obtained surfaces to undergo any finishing or protection treatment. Sharp edges may be smoothed down with sandpaper.

**3.3.2 Drilling recommendations:**

ProdEX panels are drilled using whole hard metal bits or steel bits with tungsten carbide tips (Widia) with an angle over 100°. Support sheets must be placed under the board to achieve a clean hole.

**• Clearance of holes for screws**

All the holes for the exposed fixing board's holding screws must be 3 mm greater than the diameter of the screw used, except the hole at the board's geometric centre, which may be the same size as the screw. The screws' clearance enables the board to expand and contract freely, without the screw being forced at any time in a perpendicular direction to its axis.

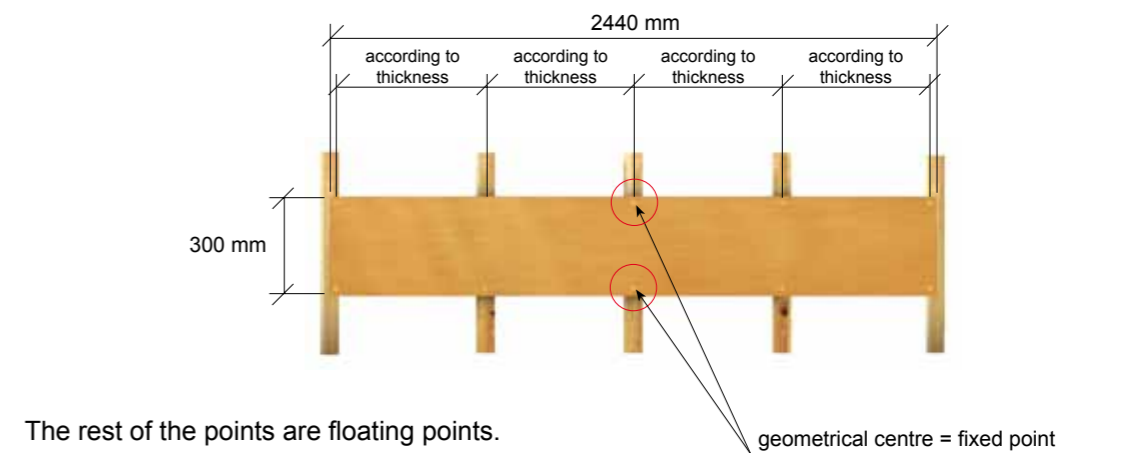
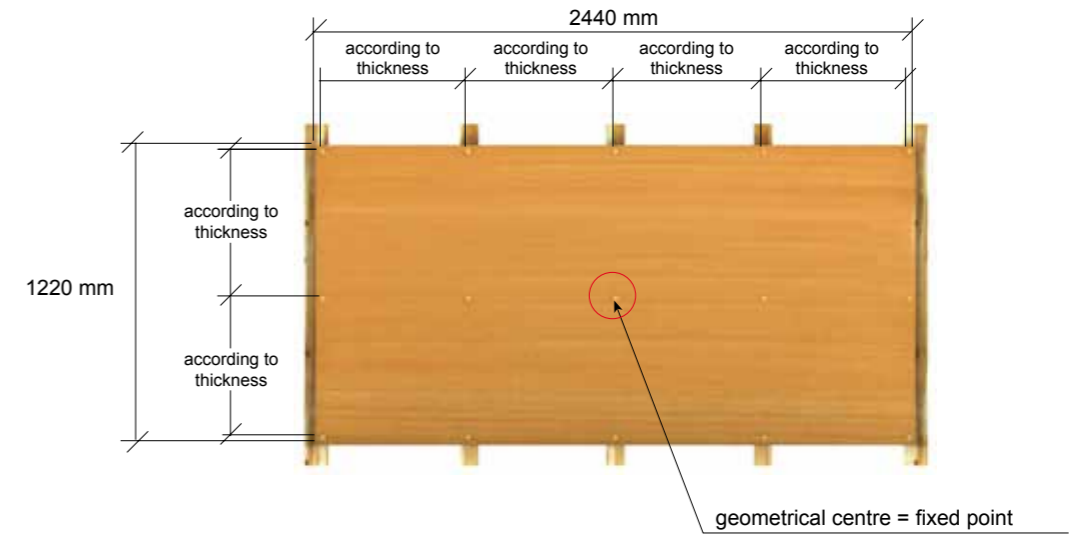

The rest of the points are floating points.

**Metal sub-structure with self-drilling SFS-SX3-L12-5.5 x 32 mm screw**

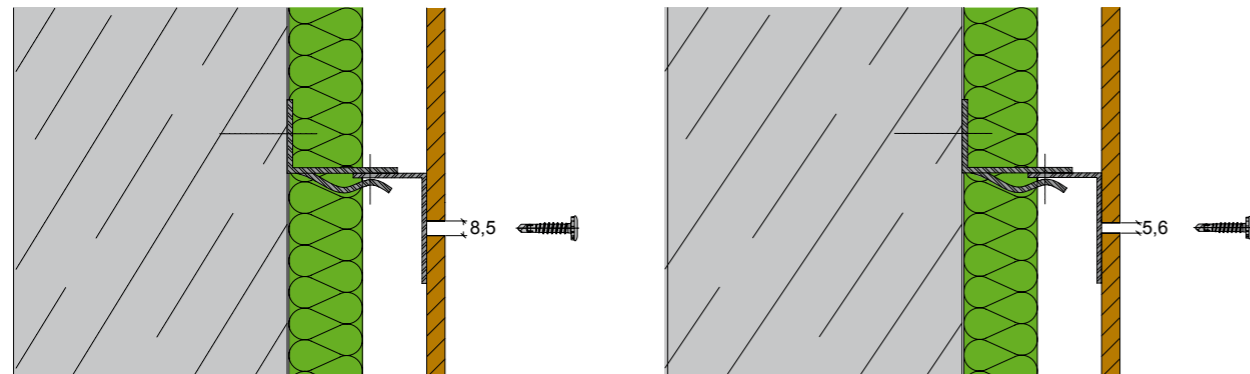

- Floating points  
Pre-drilling of board with 8.5 mm

- Fixed points  
Pre-drilling of board with 5.6 mm

**Metal sub-structure with SFS-AP-16-50XXX rivet**

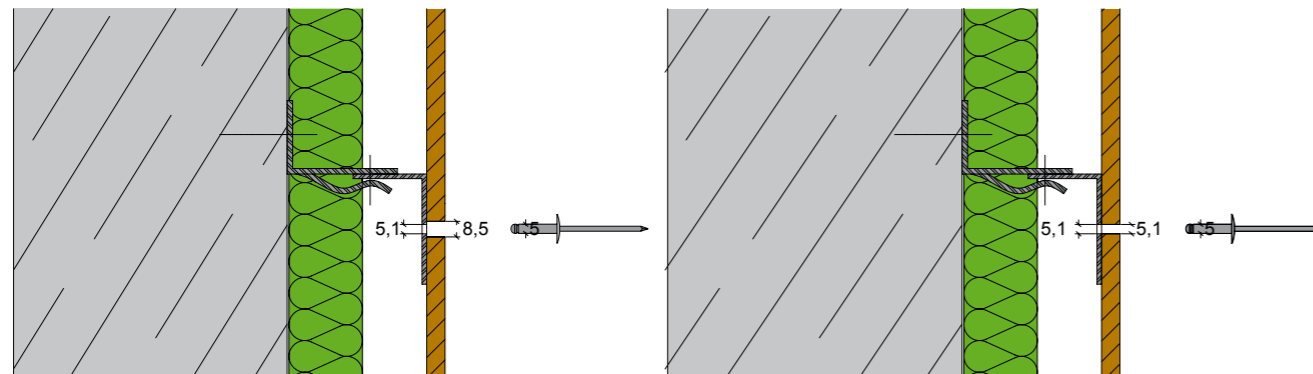

- Floating points  
Pre-drilling of board with 8.5 mm  
Pre-drilling of profile with 5.1 mm

- Fixed points  
Pre-drilling of board with 5.1 mm  
Pre-drilling of profile with 5.1 mm

**Wooden sub-structure with SFS-TW-S-D12-4.8 x 38mm screws**

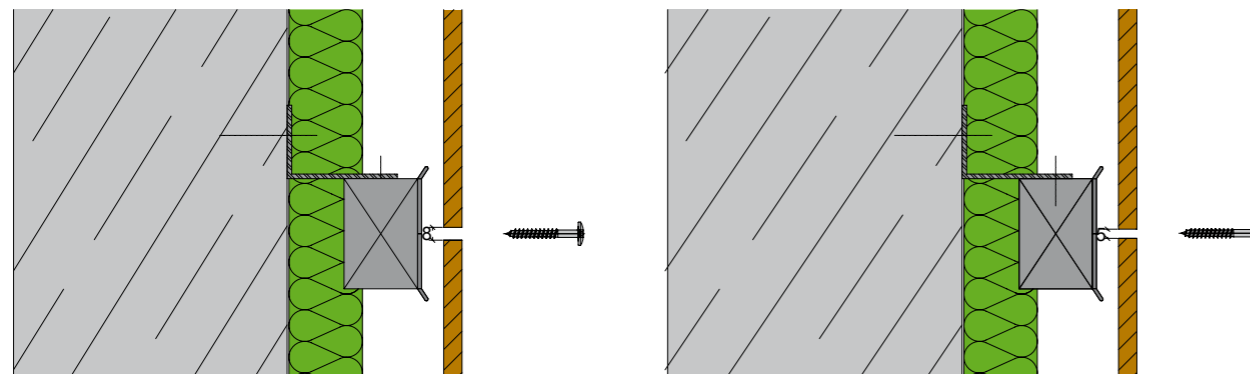

- Floating points  
Pre-drilling of board with 8 mm

- Fixed points  
Pre-drilling of board with 4.9 mm

### 3.4. Remove surface protection film

**ProdEX** boards come protected by a special film on the exposed side. This protection film is applied in the factory and must be removed from the board's surface once the product has been mounted. Never attempt to remove the film from the back of the board, as this is not a protection film and is necessary for the board's stability.

The panel must not be left installed or exposed to the elements with the exterior protection film still in place for more than 2-3 hours, to prevent the film from becoming too firmly stuck to the panel which would mean it would need to be subsequently removed with special products, and to prevent the board from warping.



### 3.5. Maintenance and cleaning



The **ProdEX** surface is a dirt repellent, but despite that, over time it may be necessary to clean the surface to bring back the boards' initial beauty and appearance.

Cleaning the **ProdEX** boards is the only maintenance process necessary. The formula patented by **Prodema** that covers the **ProdEX** boards' surface means it needs no other preventive wood treatment.

#### • The following general indications for periodic cleaning are recommended

- Always use NON-ABRASIVE household detergents diluted in water.
- Never use abrasive cleaning powder or cream that could scratch the surface.
- Always rinse with plenty of clean water to prevent the appearance of marks.
- Use a soft, clean cloth or sponge that will not damage the surface. Do not use steel wool pads that can scratch the surface.
- The dry surface must not be scratched.
- Where there is persistent grime (especially oil) or if the grime cannot be removed with only an anti-static cleaning liquid, the panel's surface must be cleaned with a soft fabric cloth or sponge dampened in benzene-free petroleum ether (40-60 °C, light naphtha).
- Aggressive solvents such as acetone, nail polish remover, etc. must not be used, since they may cause permanent damage to the protective surface film by partially or completely dissolving or cracking, which may not be seen with a first glance.

- Removing stains from the product: Most stains can be easily removed with water and household detergents. However, when necessary, a universal solvent may be used but the surface should be gently rubbed with water and a NON-ABRASIVE household detergent immediately afterwards, and then rinsed with clean water. Do not use abrasive products or cleaning products with heavily alkaline and/or acid components. You are advised not to use nitrocellulose-based thinners as they may cause stripes to appear on the boards.

**We recommend you always carry out a cleaning test on a small area of the material to verify that the procedure is effective, and only then should you go on to clean the rest of the surface in the same way.**

#### • Some of the most common stains that may be produced on site can be cleaned in the following way

- Cement stains: if the cement is still fresh, it can be easily removed with water. However, if the cement has started to set, you must wait for it to completely dry before removing it with a cloth. It is important NOT TO SCRATCH the surface, as this will damage the panel; dry stains come off easily without scrubbing. Rinse with plenty of water.
  - Remains of glue or adhesive: these can be removed with a multi-use solvent or alcohol. In any case, you should always follow this process by cleaning with soap and water.
  - Paint and primer: check with the manufacturer. Always clean with soap and water at the end.
  - Oil stains: use warm water and a non-abrasive household detergent; there is no need for solvents.
  - Scratches and dents: there is no repair method for scratched or dented panels.
- IMPORTANT NOTE: always follow the appropriate health and safety rules when using solvents and chemical cleaning products.
- Cleaning graffiti: **ProdEX** panels undergo a process that makes them resistant to graffiti. Nevertheless, specific products may be required to clean this type of paintwork. We recommend that you clean with soap and water after this process and rinse with plenty of clean water to remove any traces of the product. Panels with stubborn stains caused by remnants of glue, paint, lipstick, etc., can be cleaned with an organic solvent.

### 3.6. Repairing a damaged panel

Natural wood is a delicate material. There is no prescribed repair method for **ProdEX** panels. Damaged panels must be replaced by new ones.

# 4. Accessories

## 4.1. Strips

### 4.1.1 Aluminium:

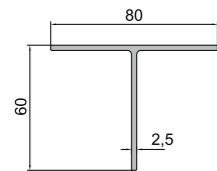

Ref: T-strip.  
Material: Aluminium.  
Length: 3000 mm bar.

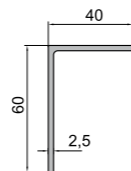

Ref: L-strip.  
Material: Aluminium.  
Length: 3000 mm bar.

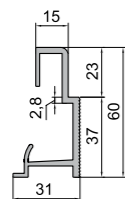

Ref: Exterior guide-strip.  
Material: Aluminium.  
Length: 3000 mm bar.

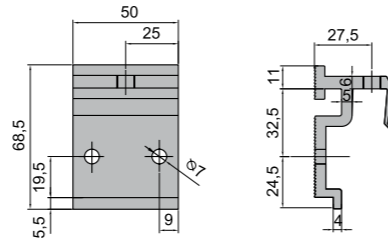

Ref: Exterior hanging hook.  
Material: Aluminium.  
Length: Piece.

\* Strips used in special projects (sold only in the U.S.A.).

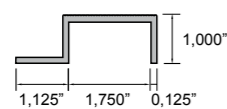

Ref: Modified Z-Channel.  
Material: Black anodized aluminium.  
Length: 146" bar.

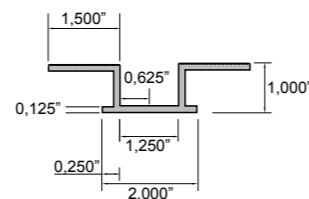

Ref: Inverted Hat-Channel.  
Material: Black anodized aluminium.  
Length: 146" bar.

### 4.1.2 Steel:

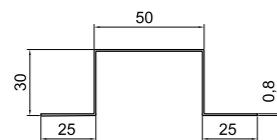

Ref: Omega strip.  
Material: Galvanised steel.  
Length: 2500 mm bar.

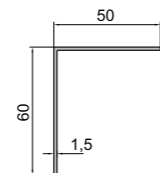

Ref: L-strip.  
Material: Galvanised steel.  
Length: 2500 mm bar.

\* Self-drilling fixings are recommended for aluminium profiles of 2.5 mm or for steel profiles of 1.5 mm in thickness. For smaller thicknesses a rivet must be used.

## 4.2. Elements for fixing to the façade

### 4.2.1 Aluminium:

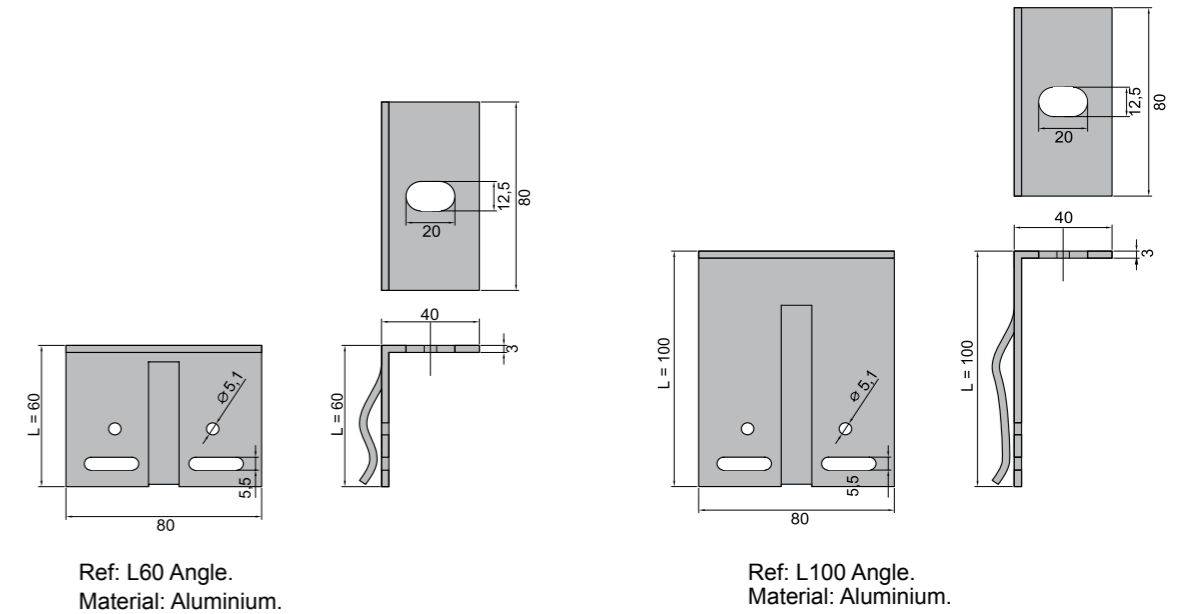

Ref: L60 Angle.  
Material: Aluminium.

Ref: L100 Angle.  
Material: Aluminium.

### 4.2.2 Steel:

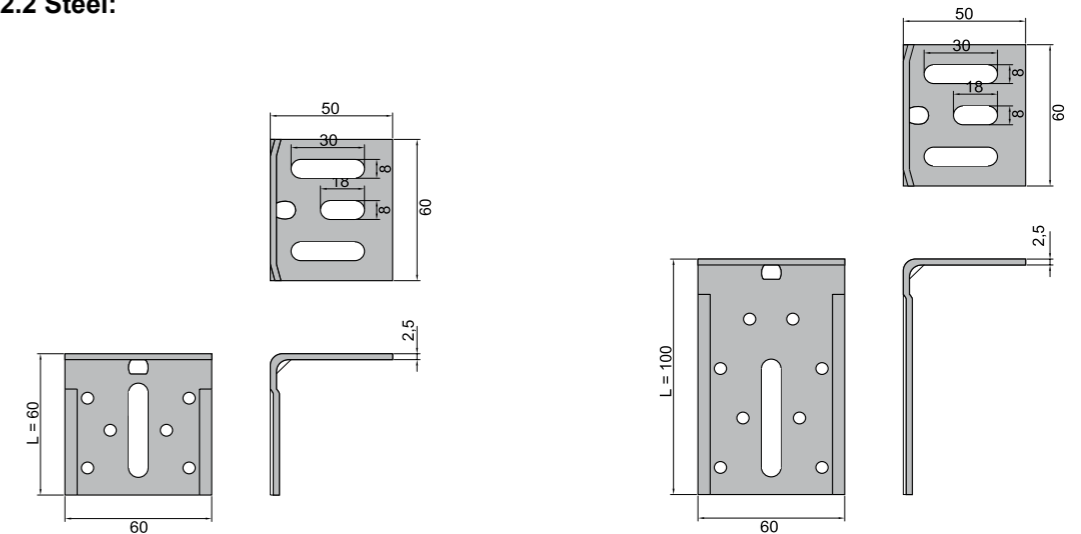

Ref: L60 Angle.  
Material: Galvanised steel.

Ref: L100 Angle.  
Material: Galvanised steel.

## 4.3. Screws and rivets

### 4.3.1 Fixing the board to the metal strip:

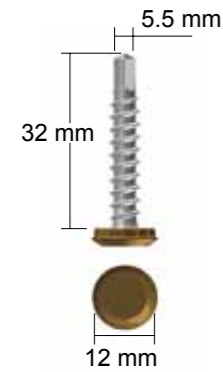

Ref: Self-drilling screw SFS-SX3-L12-5.5 x 32  
Clamping length:  $\leq 17$  mm.  
Size:  $\varnothing$  head: 12 mm.  
 $\varnothing$  screw: 5.5 mm.  
L: 32 mm.  
Material: Austenitic stainless steel 1.4567.  
Finishes: Lacquered (pg. 76) or not lacquered.

Use a special screwdriver: SFS-E 420 Federversion to correctly install the self-drilling screws. (See page 77).

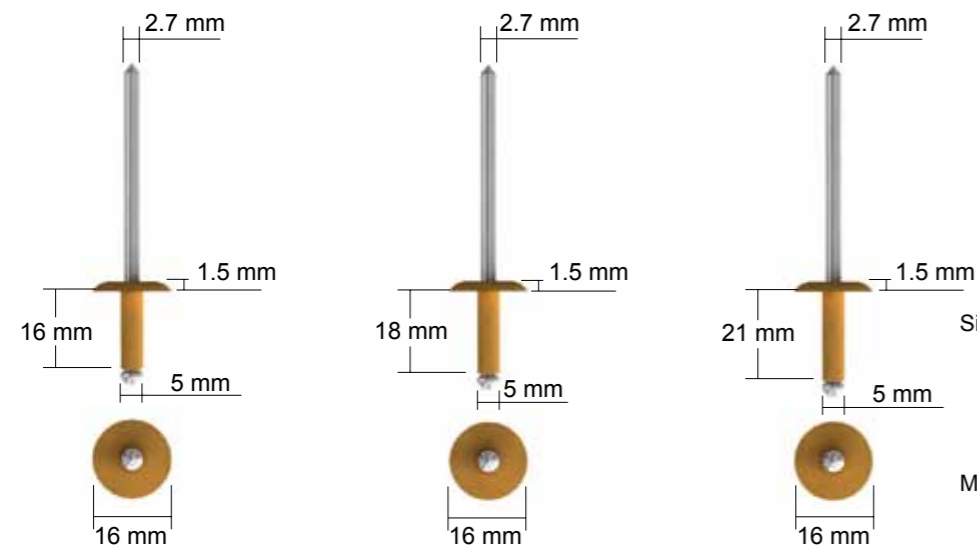

Sizes:  
 $\varnothing$  rivet: 5 mm.  
 $\varnothing$  head thickness: 1.5 mm.  
 $\varnothing$  shaft thickness: 2.7 mm.  
L: 16, 18 y 21 mm.  
Materials:  
Body: AlMg5.  
Stem: Stainless steel 1.4541.  
Finishes: Lacquered (pg. 76) or not lacquered.

Ref: Rivet.  
SFS-AP-16-50160.  
Clamping length: 8.0-12.0 mm.

Ref: Rivet.  
SFS-AP-16-50180.  
Clamping length: 9.5-13.5 mm.

Ref: Rivet.  
SFS-AP-16-50210.  
Clamping length: 12.5-16.5 mm.

### 4.3.2 Fixing the board to the wooden strip:

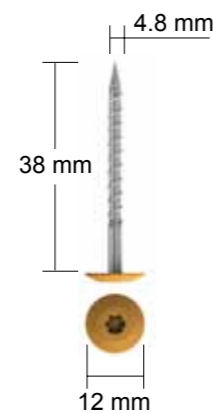

Ref: Screw SFS - TW - S - D12 - 4.8 x 38.  
Size:  $\varnothing$  head: 12 mm.  
 $\varnothing$  screw: 4.8 mm.  
L: 38 mm.  
Material: Austenitic stainless steel 1.4567.  
Finishes: Lacquered (pg. 76) or not lacquered.

To select the colour of these screws see the following page.

### Self-threading screws SFS-SX3-L-12



### Rivets SFS-AP-16-50XXX



### Screws SFS-TW-S-D12-4.8 x 38



See the screw colour chart on pg. 33.

For installation utilities, please contact **Prodema's** Technical Department.

#### 4.3.3 Fixing the board to the hanging hook:

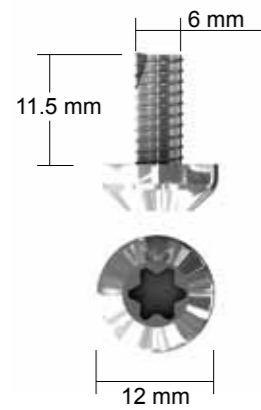

Ref: Screw Panel TB-A2 TX 30.  
 Size:  $\varnothing$  head: 12 mm.  
 $\varnothing$  screw: 6 mm.  
 L: 11.5 mm.  
 Material: Stainless steel.  
 Finishes: Stainless steel.

#### 4.3.4 Levelling pin:

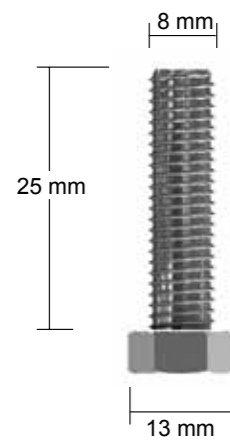

Ref: T.H Pin. / INX A2.  
 Size:  $\varnothing$  head: 13 mm.  
 $\varnothing$  screw: 8 mm.  
 L: 25 mm.  
 Material: A2 Stainless steel.  
 Finishes: Stainless steel.

### 4.4. Auxiliary elements

#### 4.4.1 Screwdriver: special tool for the Irius® head (L12) of the self-drilling screws SX3.



Ref: SFS-E 420-Federversion screwdriver.

For further information on accessories or installation utilities, please contact **Prodema's** technical department.



Cedem Carabanchel • Spain



Poßmoorweg • Germany

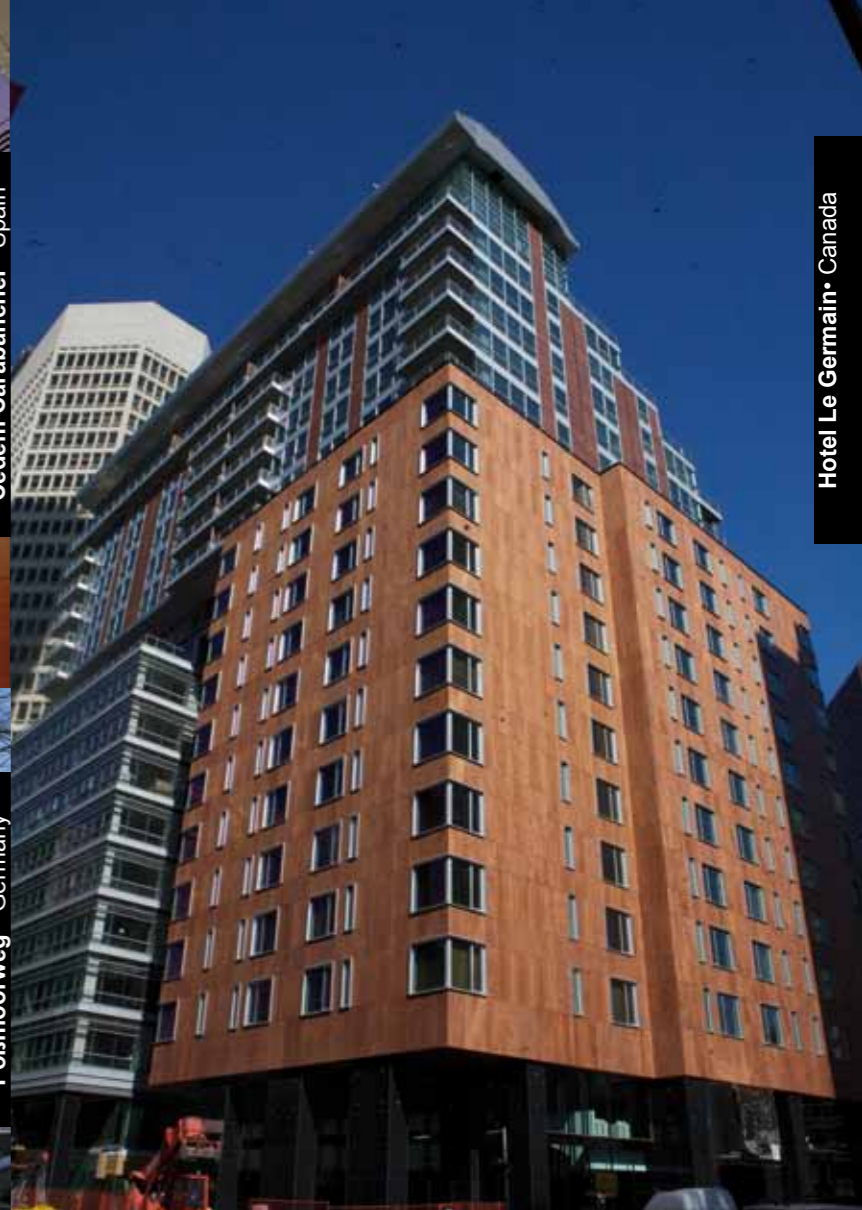

Hotel Le Germain • Canada



Surry Hills Library and Community Centre • Australia



Bochum EFH • Germany

# Other Prodema products

True beauty is inside.

And this is no exception, as the true beauty of **ProdIN** (by **Prodema**) products is found inside. Inside, deep in their core.

Because all **ProdIN** (by **Prodema**) products have a special core designed for each specific use, awarding them unique technical properties.

Cores that, together with the natural wood surface protected with the specially formulated protective film that characterises all **Prodema** products, guarantee excellent performance and incredible interior design and architectural possibilities.

## Proligna

The widest variety of colours and finishes for interior coverings, for dry environments.



## Neptuno

Damp is not a problem, with its fibre core panels that have been specially designed for damp or humid environments.

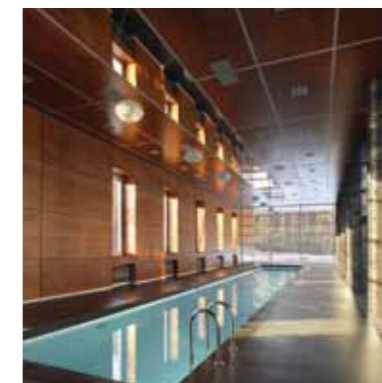

## Supra

The super wooden flooring solution that is specially designed for commercial surfaces or those subject to heavy use.



## Auditorium

The solution that combines the beauty of natural wood with an excellent level of acoustic absorption, thanks to its perforated composition.



## Laminium

The ideal range of laminates to cover raised technical floors, doors, etc.





# Prodema EXTERIORS

exteriors by Prodema®

Prodema®  
Made to last wooden Products

X

E

d

o

r

e

exteriors by Prodema®

**Prodema**<sup>®</sup>  
Made to last wooden Products

**Prodema head office and plant**

B° San Miguel, s/n • 20250 Legorreta  
Gipuzkoa (SPAIN)

T.: (+34) 943 80 70 00

F.: (+34) 943 80 71 30

E: [prodema@prodema.com](mailto:prodema@prodema.com)

[www.prodema.com](http://www.prodema.com)

Your local **Prodema** representative:
